



Инструкция по установке

TOYOTA RAV4

(20013-2019)

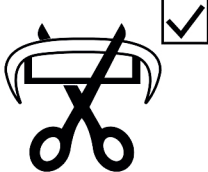

Арт.: F.5711.001

 <p>1200 kg</p>	 <p>75 kg</p>	$D \text{ (kN)} = \frac{\text{MAX kg} \times \text{MAX kg}}{\text{MAX kg} + \text{MAX kg}} \times 0,00981$
<p>D = 6.7 kN</p>		

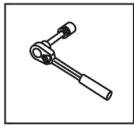

Вкрутить/выкрутить используя инструмент

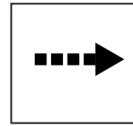

Движение

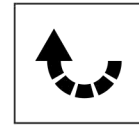

Поворот



Вкрутить/выкрутить не затягивая

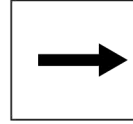





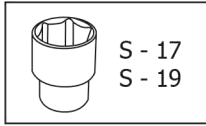
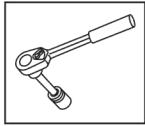

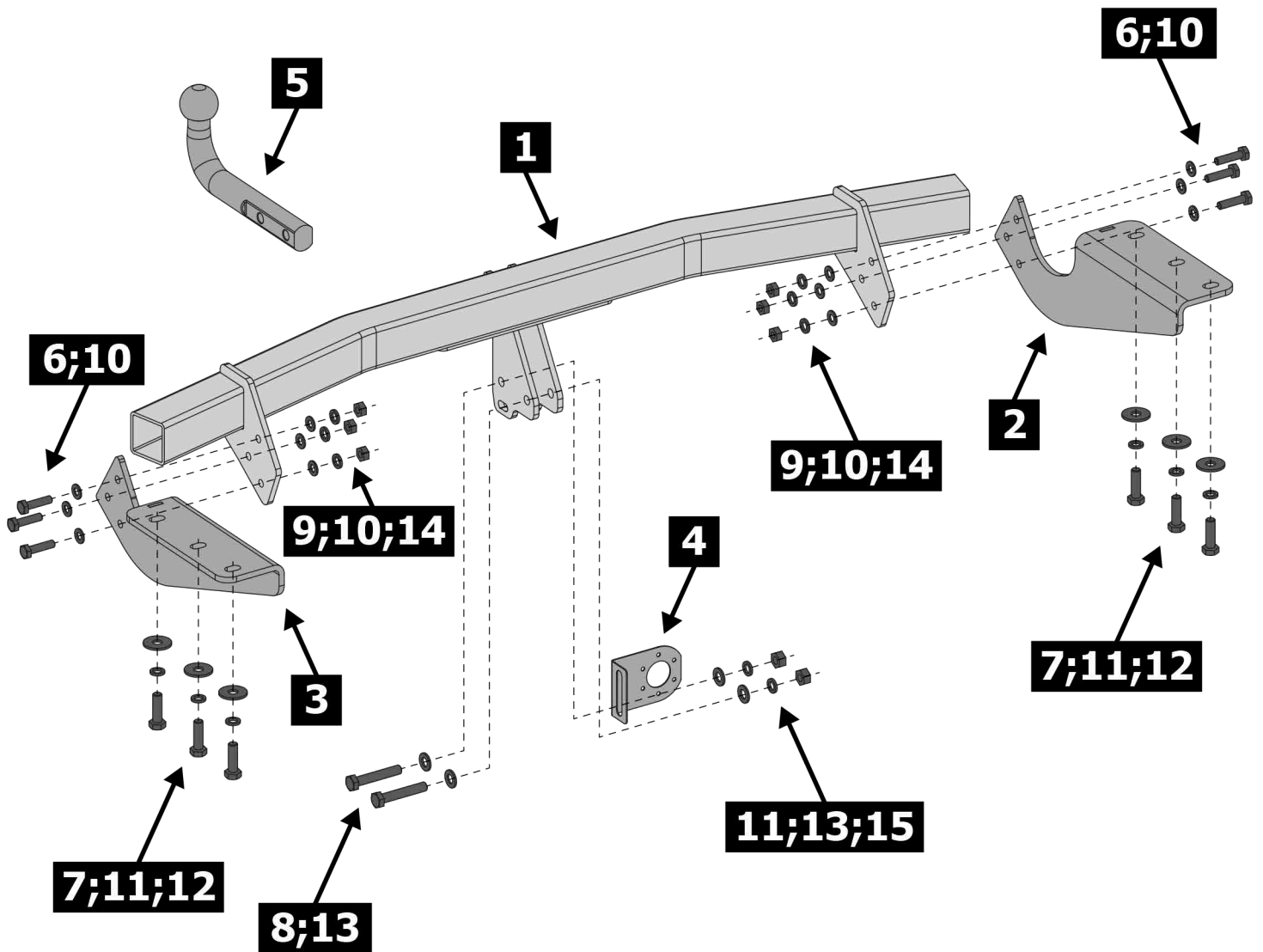

Расположение

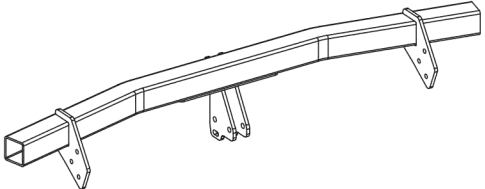
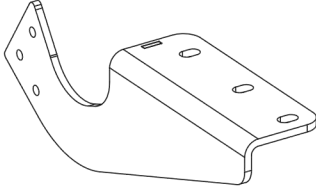
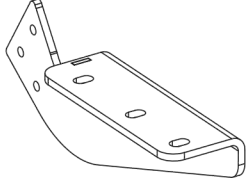
Используемый инструмент:

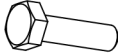
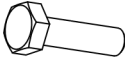

S - 17
S - 19

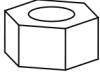
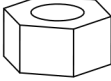

1	x1	Балка	
2	x1	Кронштейн левый	
3	x1	Кронштейн правый	
4	x1	Подрозетник	
5	x1	Крюк	
6	x6	M10x40	
7	x6	M12x40	
8	x2	M12x70	
9	x6	∅ 10	
10	x12	∅ 10	
11	x7	∅ 12	
12	x5	∅ 12	
13	x4	∅ 12	
14	x6	M10	
15	x2	M12x1.25	

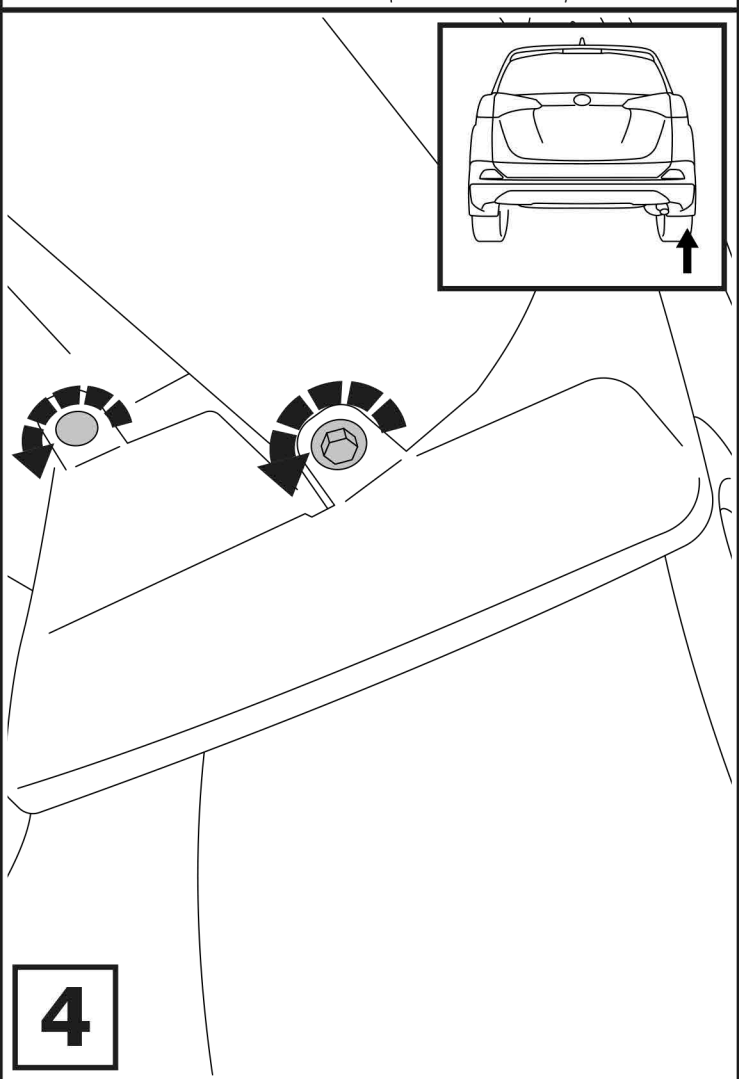
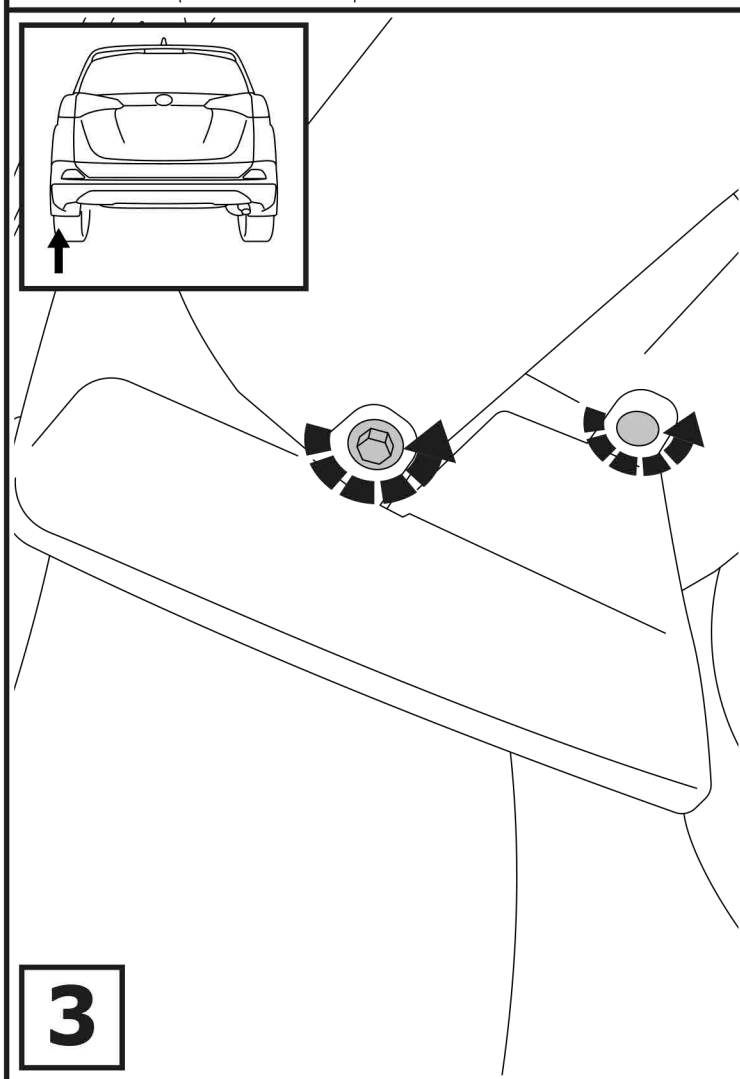
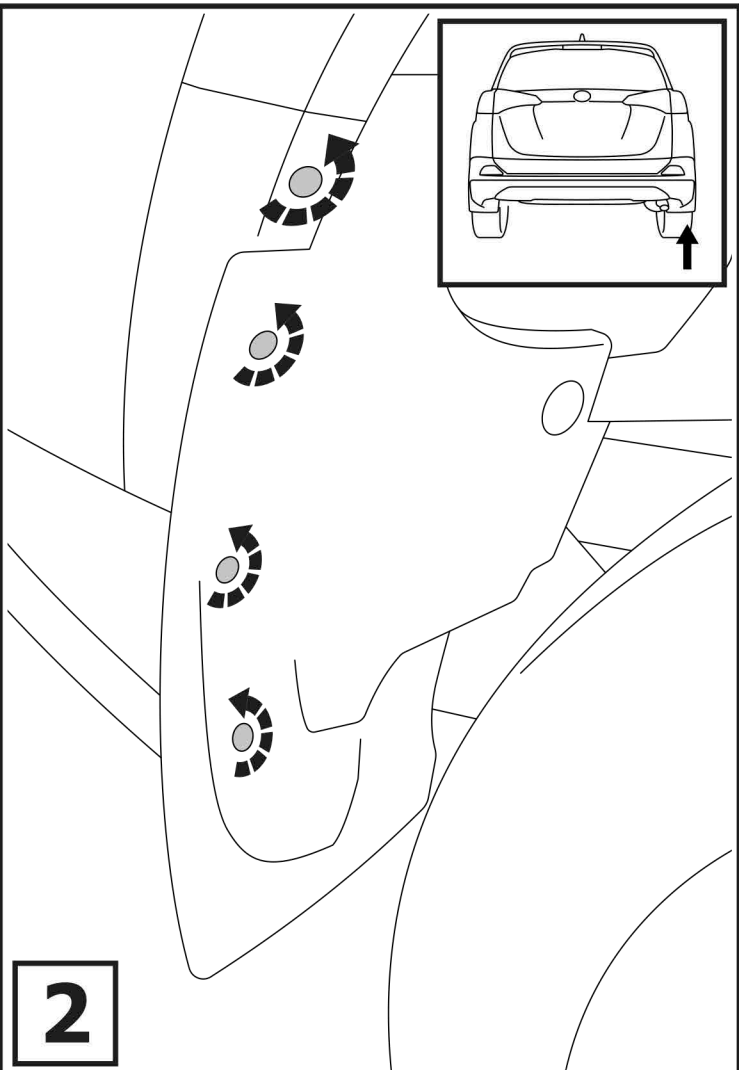
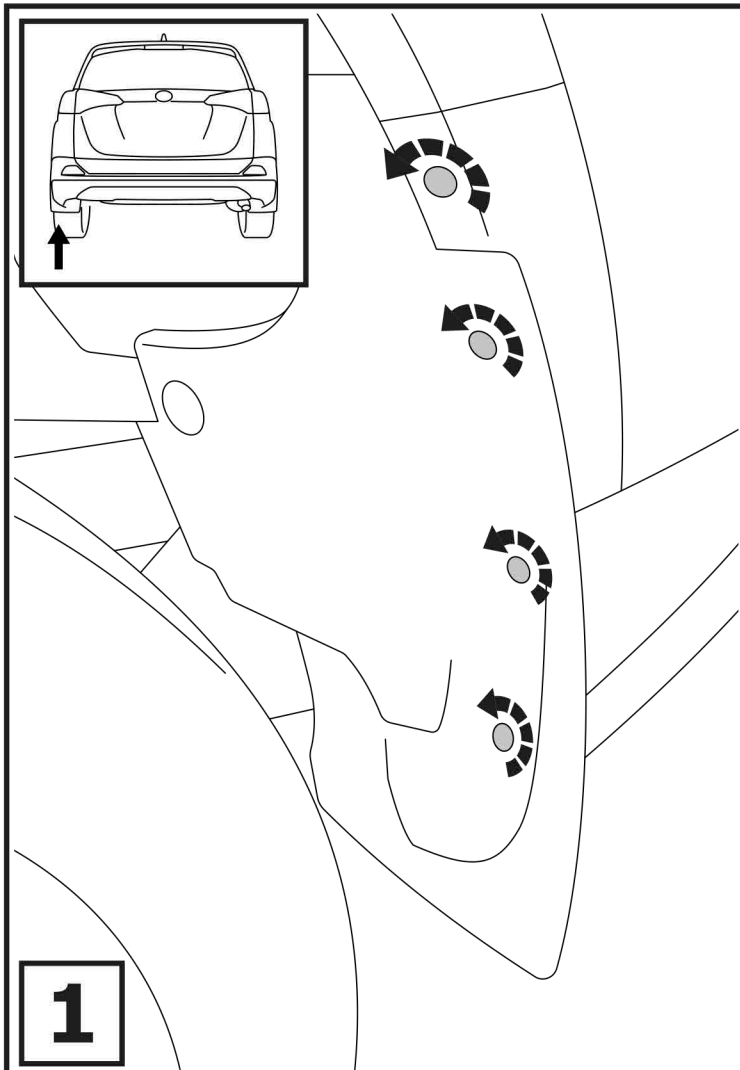

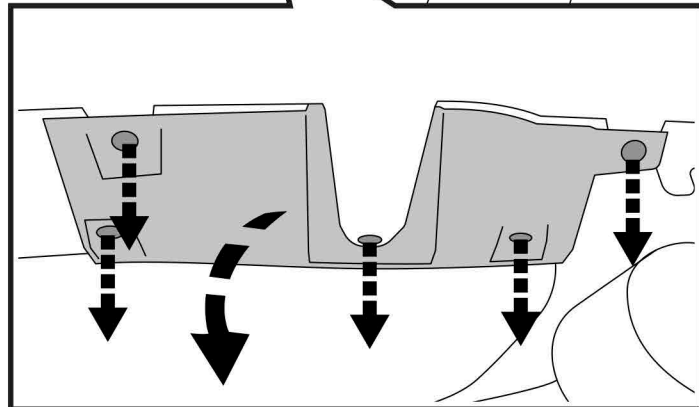
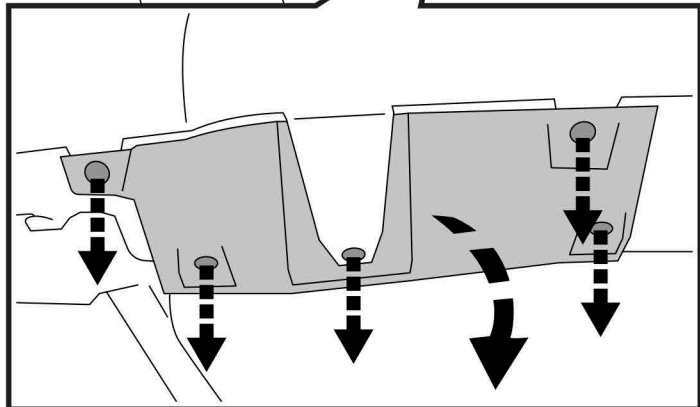
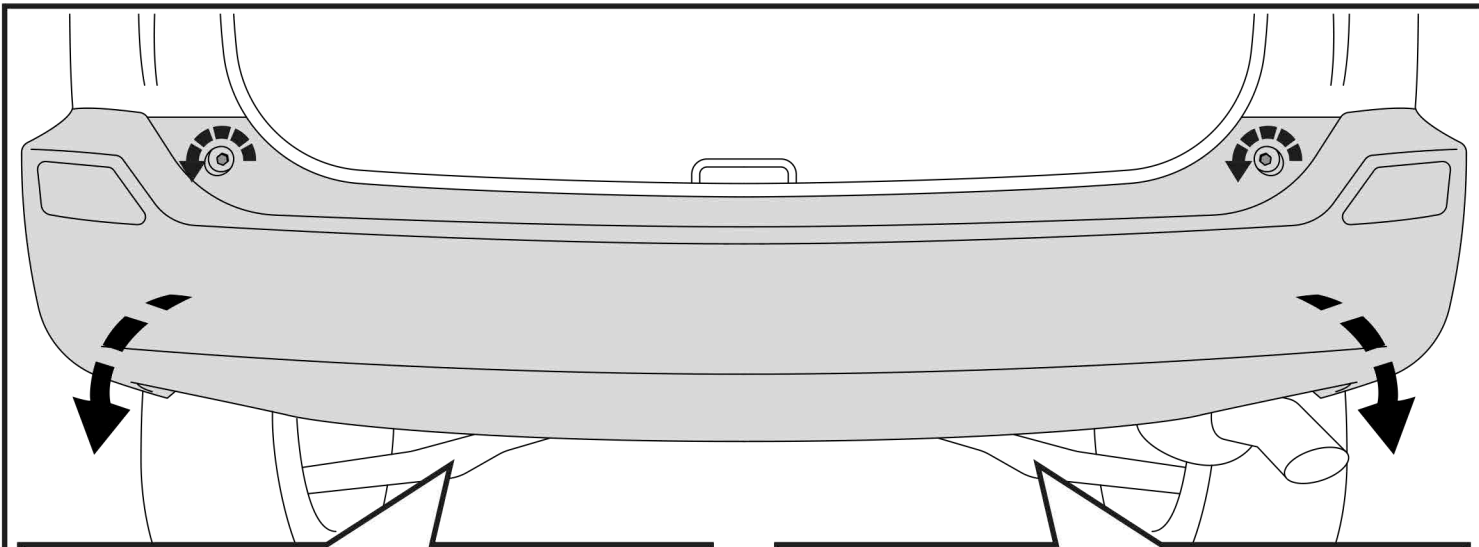

5

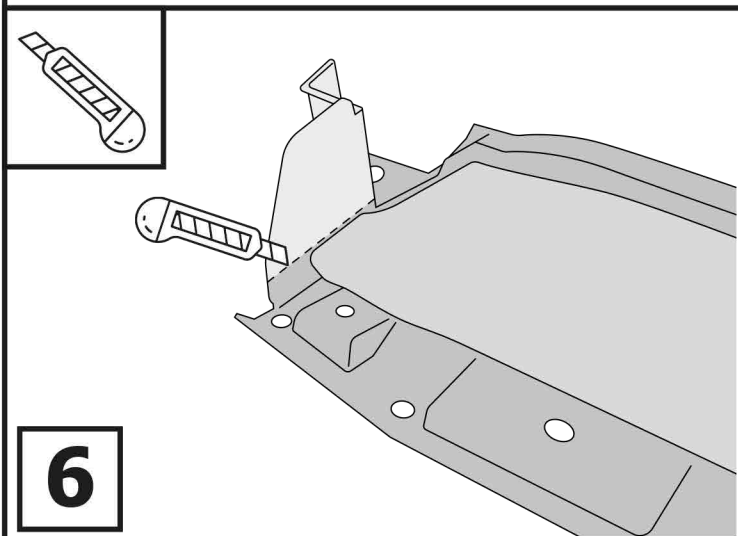

6

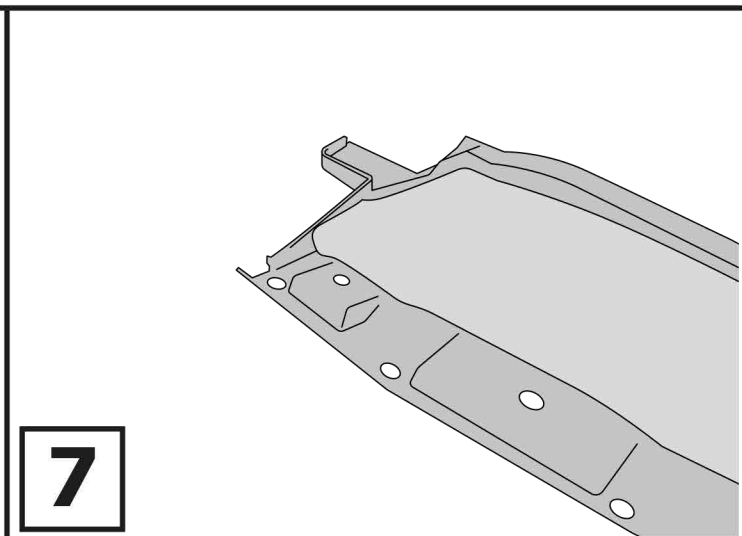

7

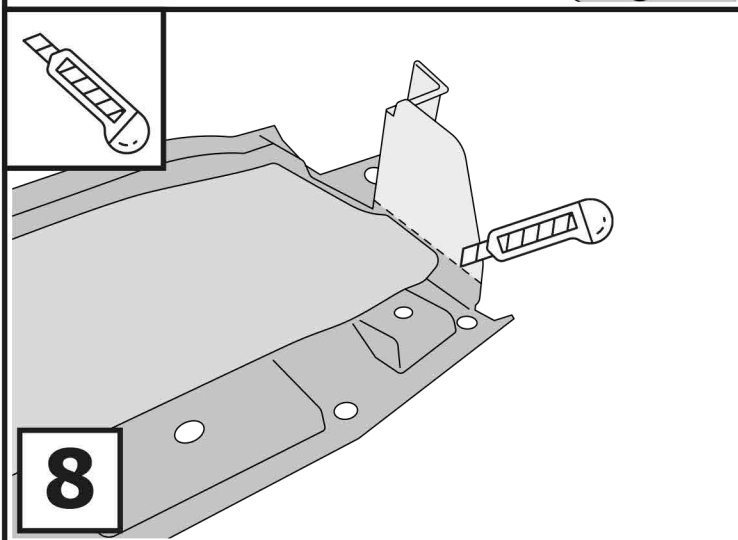

8

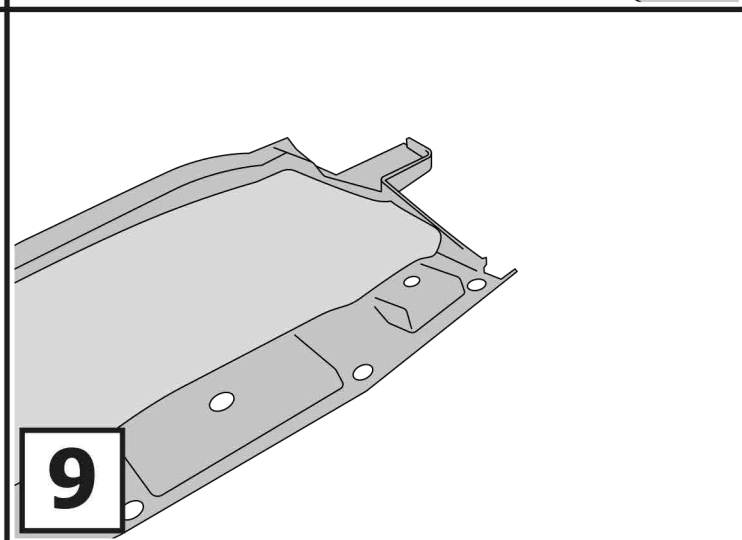

9

