

# Инструкция по установке

## Mitsubishi Pajero IV

(2007-2020)



Арт.: F.4011.001

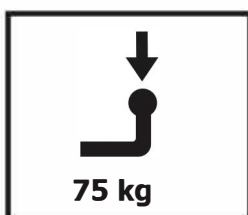
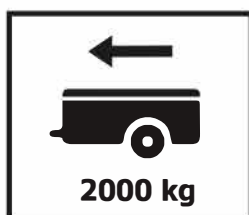

$D = 11,8 \text{ kN}$

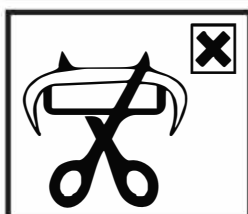

$$D \text{ (kN)} = \frac{\text{MAX kg} \times \text{MAX kg}}{\text{MAX kg} + \text{MAX kg}} \times 0,00981$$

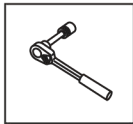

Вкрутить/выкрутить используя инструмент

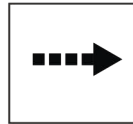

Движение



Поворот



Вкрутить/выкрутить не затягивая

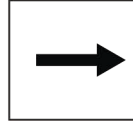

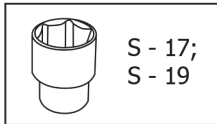
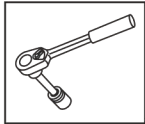

Расположение

## Используемый инструмент:

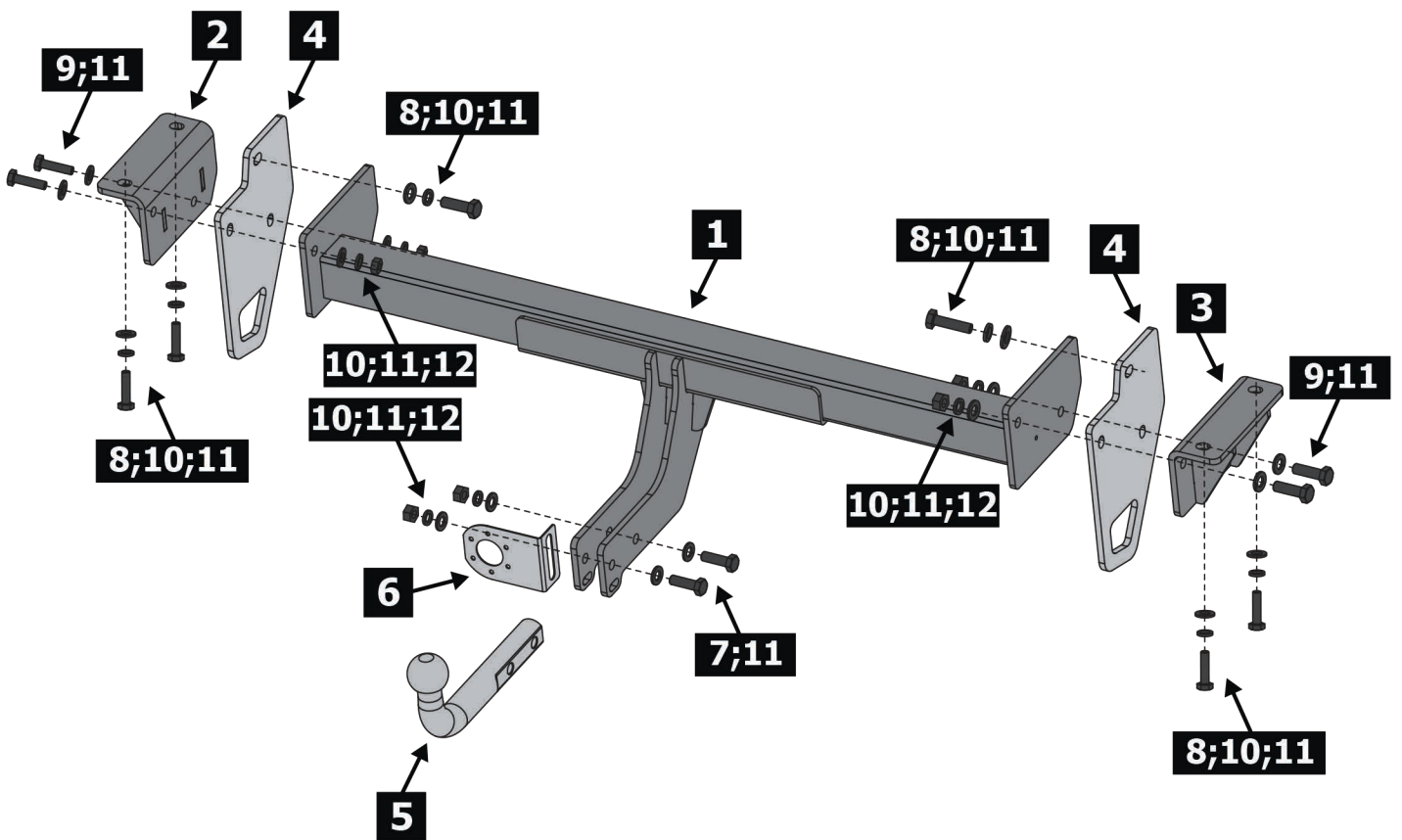

S - 17;  
S - 19

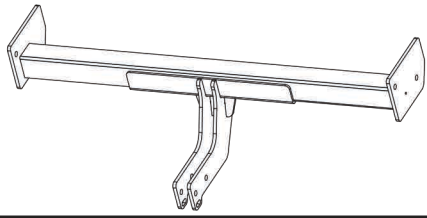
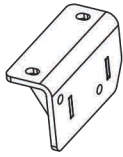
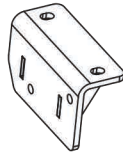
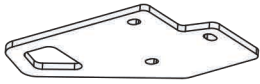
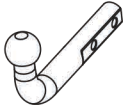
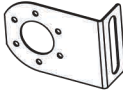
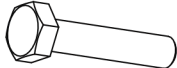
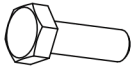
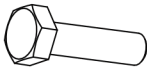

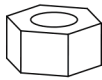
<b>1</b>	x1	Балка	
<b>2</b>	x1	Кронштейн левый	
<b>3</b>	x1	Кронштейн правый	
<b>4</b>	x1	Кронштейн балки	
<b>5</b>	x1	Крюк	
<b>6</b>	x1	Подрозетник	
<b>7</b>	x2	M12x1,25x70	
<b>8</b>	x6	M12x1,25x35	
<b>9</b>	x4	M12x1,25x45	
<b>10</b>	x12	∅ 12	
<b>11</b>	x18	∅ 12	
<b>12</b>	x6	M12x1,25	

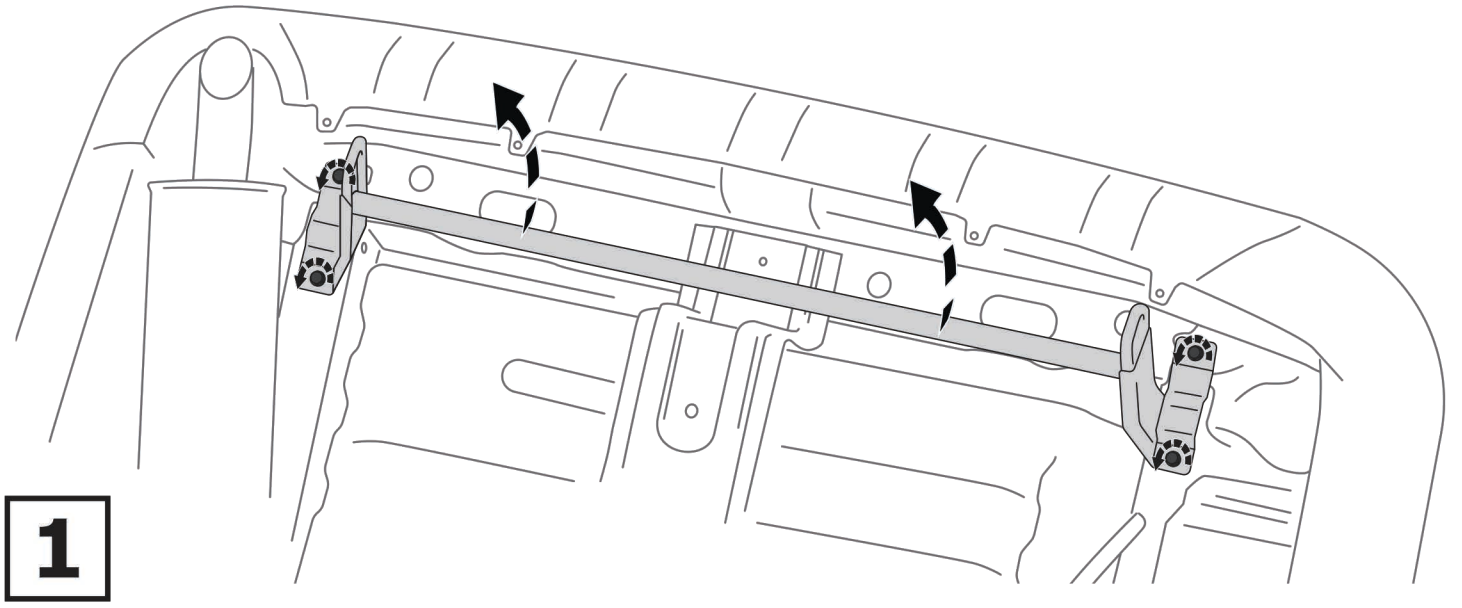
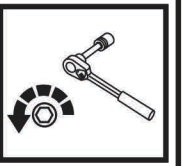

**1**

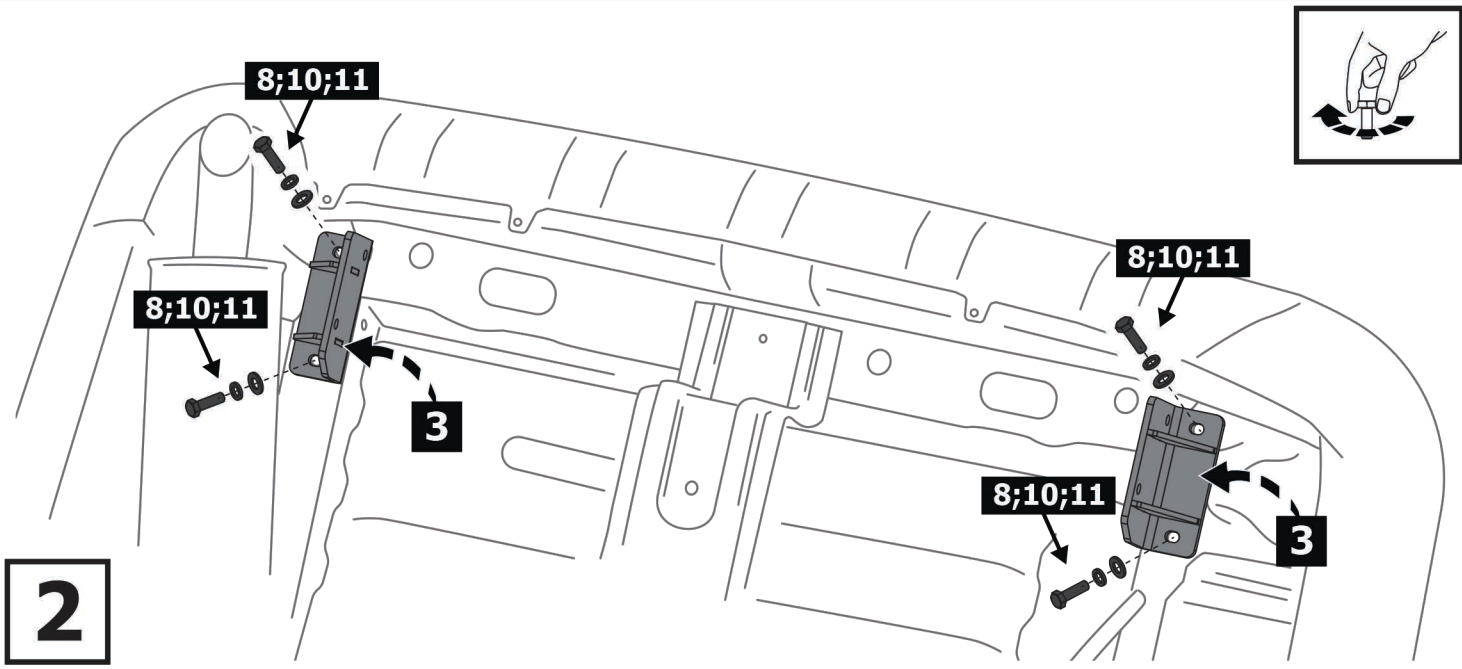

**2**

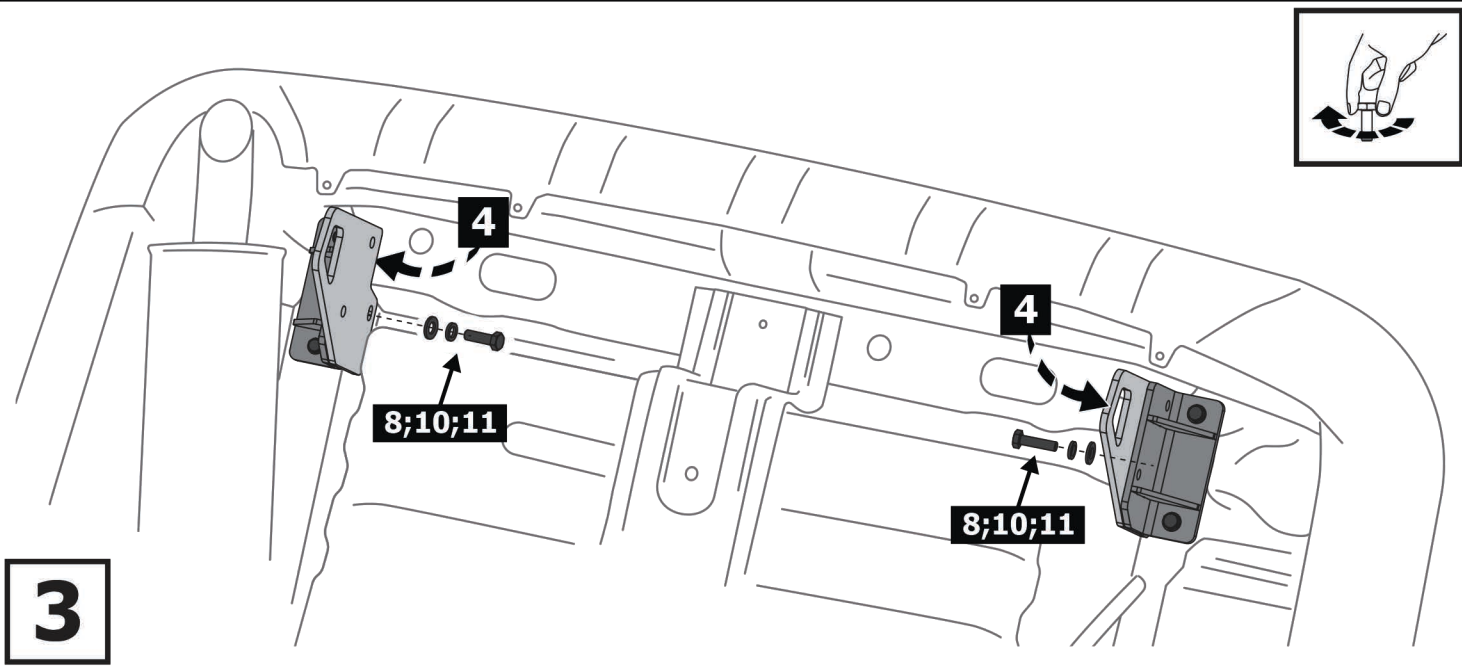
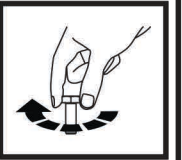

**3**

