



1996 - 08/2003

MERCEDES VITO

Cat. No. M/008

e20

E20 55R 01 1047

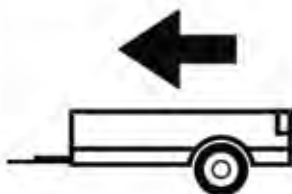

2000Kg



100Kg

D = 11,70kN

D (kN) =



MAX kg

x

MAX kg

x 0,00981



MAX kg

+

MAX kg



IMIOLA HAK-POL

96-111 KOWIESY, CHOJNATA 23A, POLAND

tel. +48 46 831 73 31, fax +48 831 74 29

e-mail: office@imiola.pl, www.imiola.pl

PRZEKRÓJ A-A

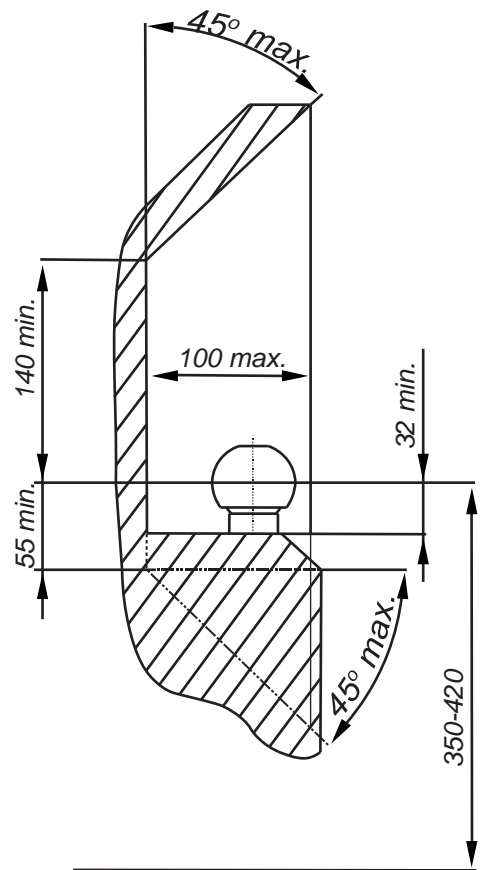
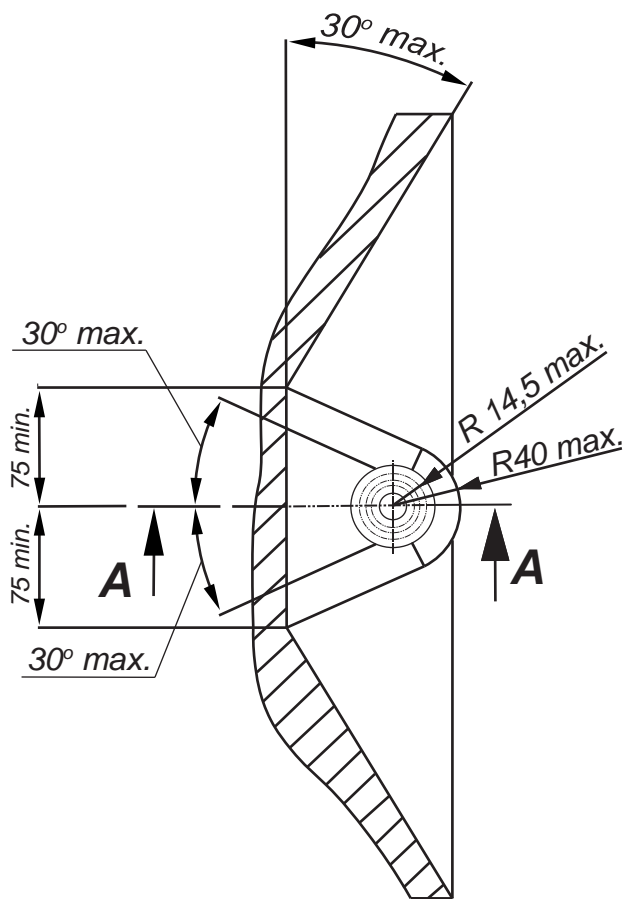

PL Należy zagwarantować przestrzeń swobodną według załącznika VII, rysunek 25a/b Regulaminu EKG ONZ 55.01 przy dopuszczalnym ciężarze całkowitym pojazdu.

GB The clearance specified in appendix VII, diagram 25a/b of Regulation No. 55.01 UN EU must be guaranteed at laden weight of the vehicle.

F L'espace libre doit être garanti conformément à l'annexe VII, illustration de la réglementation 55.01 CE pour un poids total en charge autorisé du véhicule.

D Der Freiraum nach Anhang VII, Abbildung 25a/b der Vorschriften 55.01 EG ist zu gew 25a/b abzugeben bei zulässigem Gesamtgewicht des Fahrzeuges.

Moment skręcający dla śrub i nakrętek (8.8) Torque settings for nuts and bolts (8.8)	
M8	25Nm
M10	55Nm
M12	85Nm
M14	135Nm
M16	195Nm

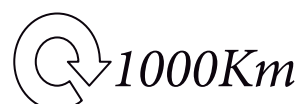

Nakrętka M10 ; Nut
 Podkł. spręż. 10,2 ; Spring Washer
 Podkł. okr. Ø30x Ø10,5x 3 ; Plain Washer

Nakrętka M12 ; Nut
 Podkł. spręż. 12,2 ; Spring Washer
 Podkł. okr. 13 ; Plain Washer

Śruba M10x100-8.8 ; Bolt
 Podkł. okr. Ø30x Ø10,5x 3 ; Plain Washer

Śruba M12x100-8.8 ; Bolt

Podkł. okr. Ø36x Ø13x 3 ; Plain Washer

Śruba M10x100-8.8 ; Bolt
 Podkł. okr. Ø30x Ø10,5x 3 ; Plain Washer











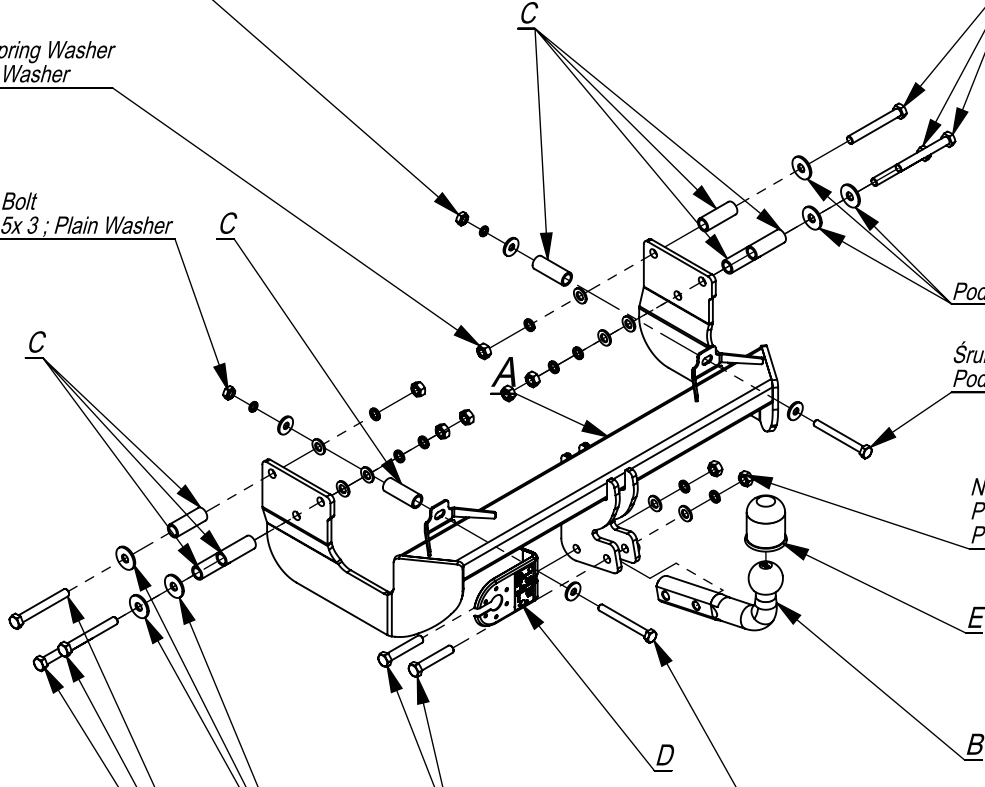
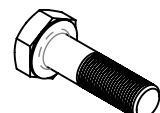

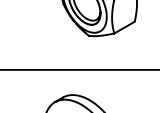
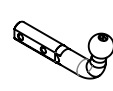
Nakrętka M12 ; Nut
 Podkł. spręż. 12,2 ; Spring Washer
 Podkł. okr. 13 ; Plain Washer

Śruba M10x100-8.8 ; Bolt
 Podkł. okr. Ø30x Ø10,5x 3 ; Plain Washer

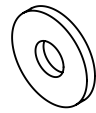
Śruba M12x70-8.8 ; Bolt

Podkł. okr. Ø36x Ø13x 3 ; Plain Washer

Śruba M12x100-8.8 ; Bolt

	A	x1		M12x100	6
				M12x70	2
				M10x100	2
	B	x1		M12	8
				M10	2
	C	x8		Ø36xØ13x3	6
				Ø30xØ10,5x3	4
	D	x1		13	8
	E	x1		12,2	8
				10,2	2

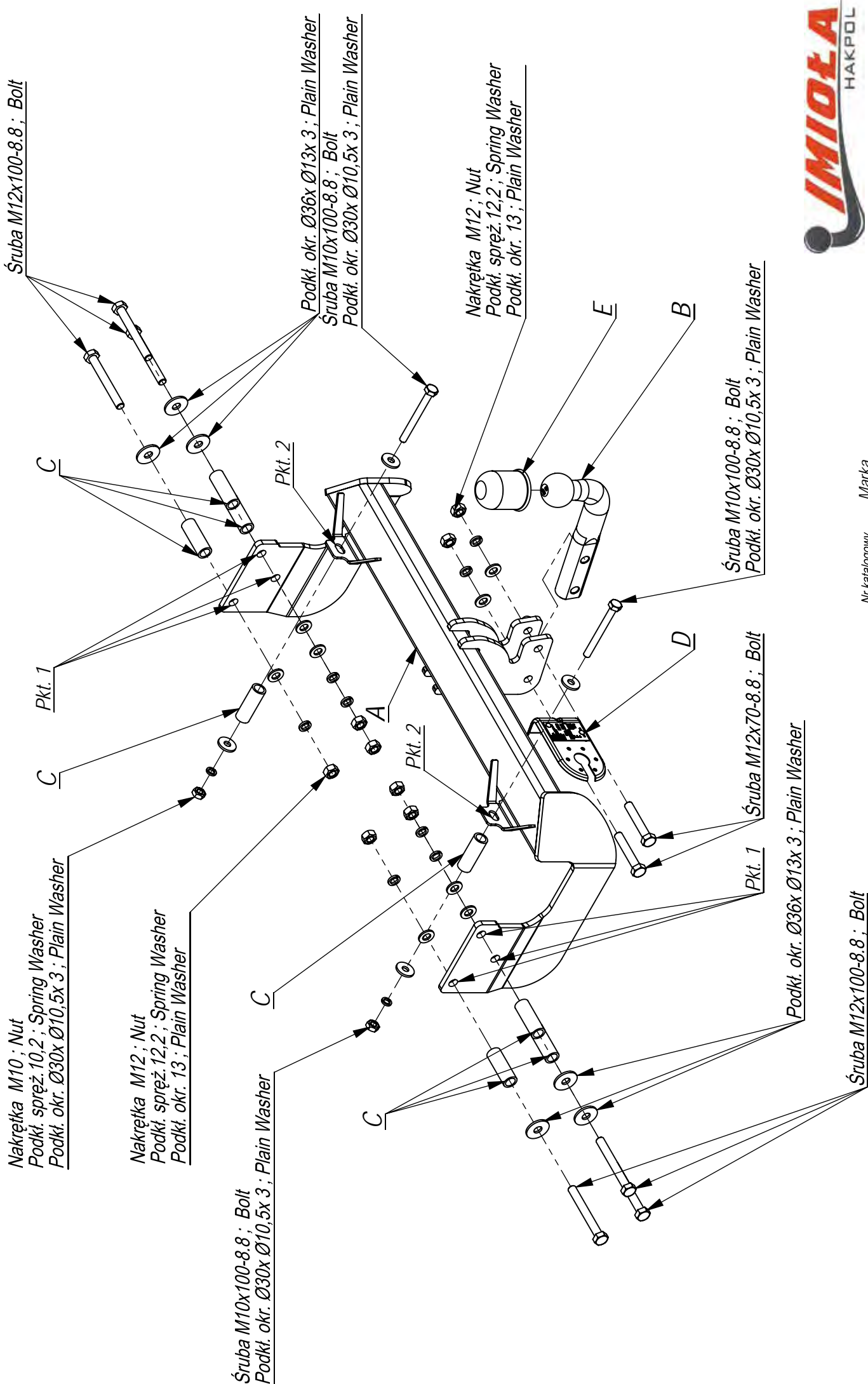

96-111 Kowiesy, Chojnata 23 A
tel. +48 46 831 73 31

Nr katalogowy M/008
 Marka Mercedes Vito od 96-08/03

- Odkręcić zderzak.
- W technologiczne otwory w lewej i prawej podłużnicy oraz w tylnym pasie włożyć tuleje dystansowe D L= 60.
- Przyłożyć belkę haka i skręcić śrubami M12x100 8.8 (pkt 1) stosując nakładki C i śrubami M10x100 8.8 (pkt 2).
- Dokręcić wszystkie śruby z momentem wg tabeli.
- Wykonać wycięcie w dolnej części zderzaka wg rysunku.
- Przykręcić zderzak.
- Przykręcić kulę i blachę gniazda elektrycznego śrubami M12x70 8.8.
- Podłączyć instalację elektryczną.

- Unscrew the bumper.
- Insert the distance sleeves D L= 60 in the technological holes, in the left and right metal clamp and rear belt.
- Put the main bar and screw with bolts M12x100 8.8 (point 1) using plates C and with bolts M10x100 8.8 (point 2).
- Tighten all the bolts according to the torque setting- see the table.
- Cut out the fragment in the lower part of the bumper, according to the drawing.
- Screw the bumper.
- Fix the ball and electric plate with bolts M12x70 8.8.
- Connect the electric wires.

- Dévisser le pare-chocs.
- Infiler des douilles de distance D L=60 dans des trous technologiques dans le longeron gauche et droit et dans la bande postérieure.
- Mettre la poutre du crochet d'attelage et serrer avec les boulons M12x100 8.8 (point 1) en utilisant les rondelles C et les boulons M10x100 8.8 (point 2).
- Serrer tous les boulons avec un couple de serrage selon tableau.
- Réaliser une coupure dans la partie inférieure du pare-chocs selon le dessin.
- Monter le pare-chocs.
- Visser le crochet d'attelage et socle de prise électrique par les boulons M12x70 8.8.
- Raccorder le circuit électrique.

