



TOYOTA RAV4
hybrid

11/2018 -

Cat. No. T/072

E20

E20*55R01/07*005823*00

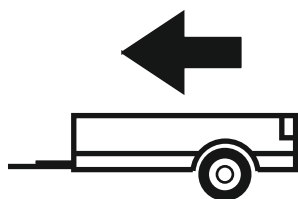

2000kg

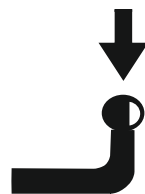

80kg

D = 10,90kN

D (kN) =



MAX kg

x

MAX kg

x 0,00981



MAX kg

+

MAX kg

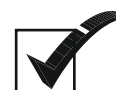
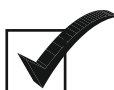

IMIOLA HAK-POL

96-111 KOWIESY, CHOJNATA 23A, POLAND

Tel. + 48 46 831 73 31, fax +48 831 74 29

e-mail: office@imiola.pl, www.imiola.pl



PRZEKRÓJ A-A



PL Należy zagwarantować przestrzeń swobodną według załącznika VII, rysunek 25a/b Regulaminu EKG ONZ 55.01 przy dopuszczalnym ciężarze całkowitym pojazdu.

F L'espace libre doit être garanti conformément à l'annexe VII, illustration de la réglementation 55.01 CE pour un poids total en charge autorisé du véhicule.







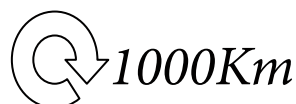

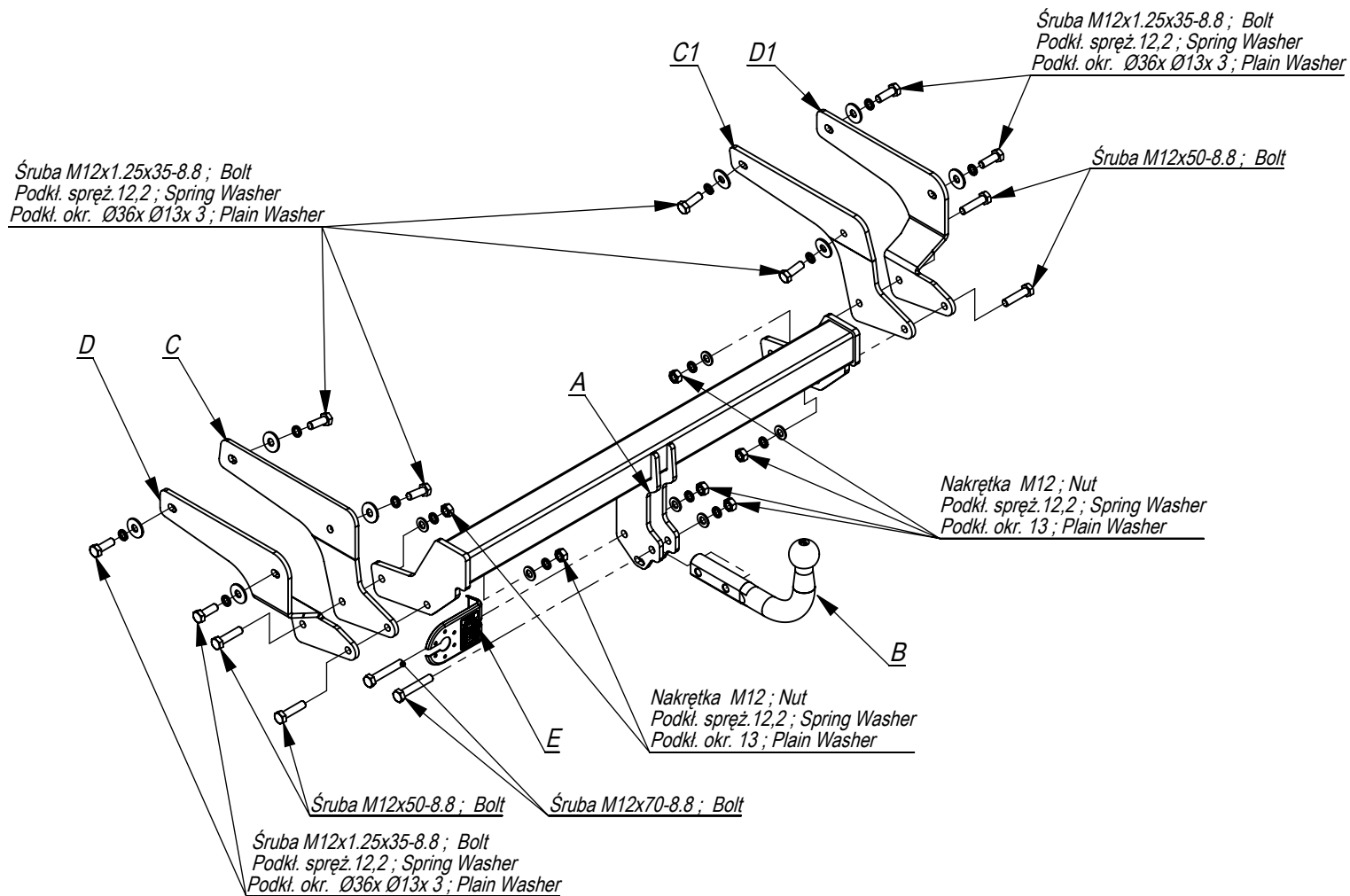

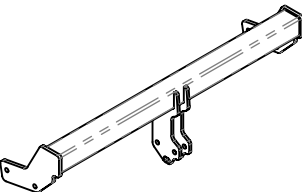
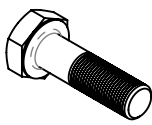
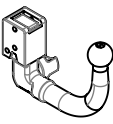
GB The clearance specified in appendix VII, diagram 25a/b of Regulation No. 55.01 UN EU must be guaranteed at laden weight of the vehicle.

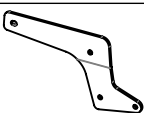
D Der Freiraum nach Anhang VII, Abbildung 25a/b der Vorschriften 55.01 EG ist zu gewährleisten bei zulässigem Gesamtgewicht des Fahrzeuges.

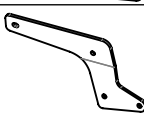
Moment skręcający dla śrub i nakrętek (8.8) Torque settings for nuts and bolts (8.8)	
M8	25Nm
M10	55Nm
M12	85Nm
M14	135Nm
M16	195Nm

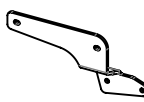

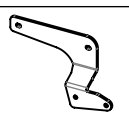

	A	x1		M12x1,25x35	8
				M12x50	4
				M12x70	2
	B	x1		M12	6
	C	x1		Ø36xØ13x3	8
	C1	x1		13	6
	D	x1		12,2	14
	D1	x1			
	E	x1			

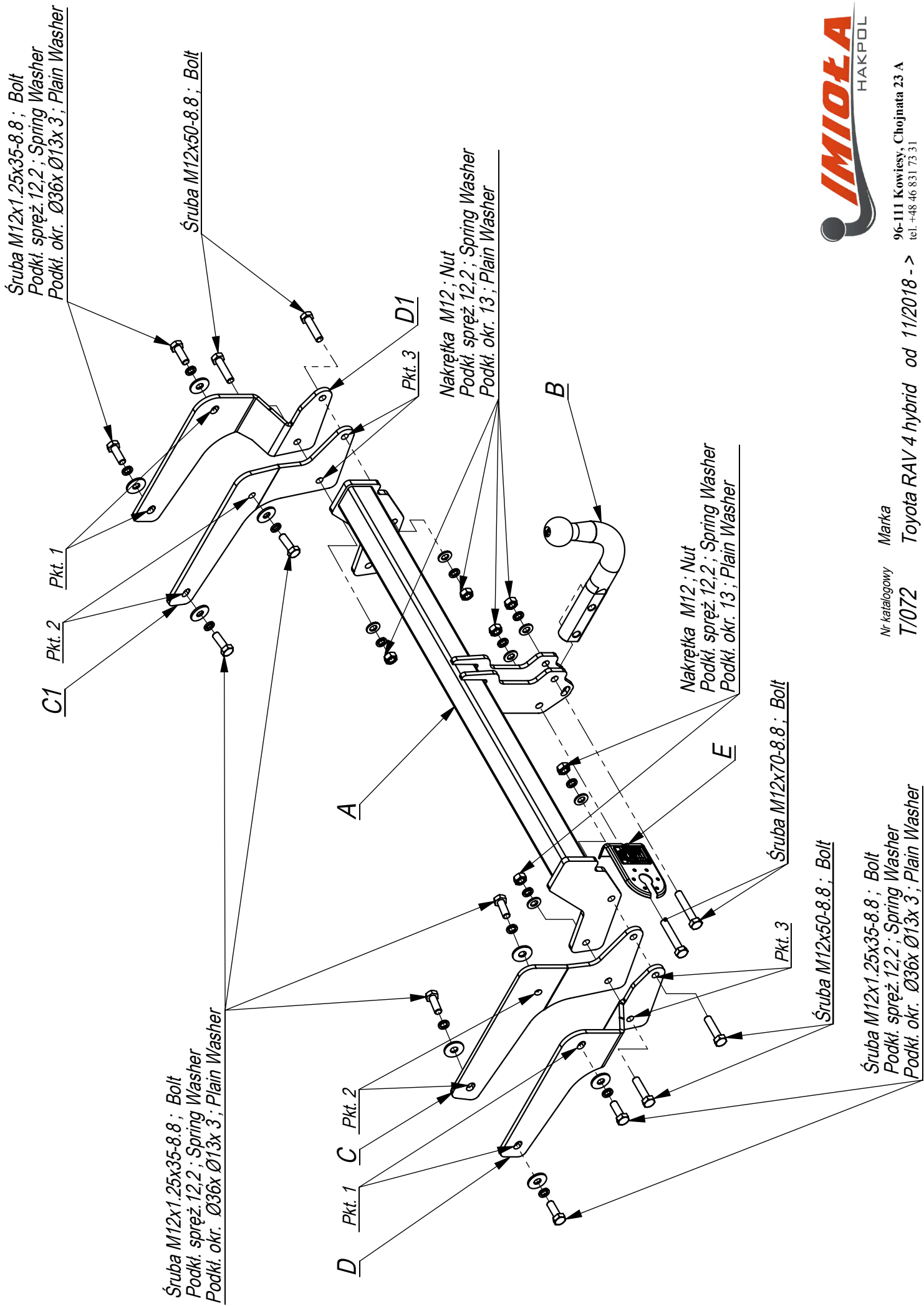

Nr katalogowy T/072 Marka Toyota

Toyota RAV 4 hybrid od 11/2018 ->

96-111 Kowiesy, Chojnata 23 A
tel. +48 46 831 73 31

- Odkręcić lampy i zderzak .
- Odkręcić belkę zderzeniową (nie będzie już wykorzystana).
- Opuścić tłumik z zawiesia.
- Odkręcić ucho holownicze.
- Przykręcić elementy haka C i D do podłużnic śrubami M12x1,25x35 8.8 (pkt 1,2).
- Przykręcić belkę zaczepu A do elementów C i D śrubami M12x50 8.8 (pkt 3).
- Przykręcić tłumik.
- Założyć zderzak i lampy.
- Przykręcić kulę i blachę gniazda elektrycznego śrubami M12x70 8.8.
- Dokręcić wszystkie śruby z momentem według tabeli.
- Podłączyć instalację elektryczną.

- Unscrew the lamps and bumper.
- Unscrew the bumper bar (it will not be used any more).
- Lower the muffler from the hanger.
- Unscrew the towing eye.
- Screw the elements C and D to the frame side members with bolts M12x1,25x35 8.8 (point 1,2).
- Screw the main bar A to the elements C and D with bolts M12x50 8.8 (point 3).
- Visser le pot d'échappement.
- Installer le pare-chocs et les lampes.
- Fix the ball and electric plate with bolts M12x70 8.8.
- Tighten all the bolts according to the torque setting- see the table.
- Connect the electric wires

- Dévisser le pare-chocs et les lampes.
- Dévisser la poutre pare-chocs de la voiture (elle ne sera plus utilisée).
- Enlever le pot d'échappement de la suspension.
- Dévisser l'anneau d'attelage.
- Visser les éléments C et D aux longerons avec les boulons M12x1,25x35 8.8 (point 1,2).
- Visser la poutre du crochet d'attelage aux éléments C et D avec les boulons M12x50 8.8 (pt 3).
- Visser la boule et la tôle de la prise électrique avec les boulons M12x70 8.8.
- Serrer tous les boulons avec un couple de serrage selon tableau.
- Brancher l'installation électrique.

- Die Rückleuchten und den Stoßfänger abschrauben.
- Den Stoßträger abschrauben (wird nicht mehr benötigt)..
- Den Schalldämpfer vom Halter absenken.
- Die Abschleppöse abschrauben.
- Die AHK-Bauteile C und D mit Schrauben M12x1,25x35 8.8 (Punkt 1,2) an den Längsträgern festschrauben.
- Den Träger von Haken A an die Bauteile C und D mit Schrauben M12x50 8.8 (Punkt 3) anschrauben.
- Den Schalldämpfer anschrauben.
- Den Stoßfänger und die Rückleuchten einsetzen.
- Schrauben Sie die Kugel und den Steckdosenblech mit den Schrauben M12x70 8.8 an.
- Ziehen Sie alle Schrauben mit dem Drehmoment gemäß der Tabelle an.
- Die elektrische Installation anschließen.

- Desenrosque las lámparas y el parachoques.
- Desenrosque la barra de impacto (ya no es necesario).
- Baje el silenciador de la suspensión.
- Desenrosque la argolla de remolque.
- Fijar los elementos C y D del gancho a los largueros con tornillos M12x1,25x35 8.8 (punto 1,2).
- Fijar el gancho A a los elementos C y D con tornillos M12x50 8.8 (punto 3).
- Fijar el silenciador.
- Montar el parachoques y las luces.
- Atornille la bola y la placa de toma de corriente eléctrica. con tornillos M12x70 8.8.
- Apretar todos los tornillos al torque de acuerdo con la tabla.
- Conectar la instalación eléctrica.

