

➤ Instructions

Thule WingBar Edge 958X / 958XB

958100, 958120, 958200, 958220, 958300, 958320,
958400, 958420, 958500, 958520

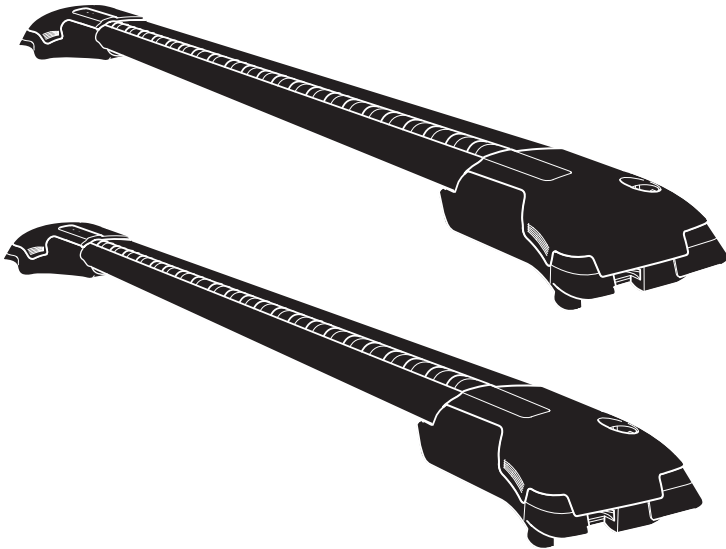

EN Roof mounted load carrier
DE Lastenträger zur Dachmontage
FR Barre de toit
NL Dakdrager
IT Barra portatutto da installare sul tetto
ES Portaequipajes de techo
PT Barra para montagem no tejadilho
SV Takmonterad lasthållare
DK Tagmonteret lastholder
NO Takmontert lasteholder
FI Katolle asennettava teline
ET Katusele paigaldatav katuseraam
LV Uz jumta uzstādāms kravas turētājs
LT Ant stogo tvirtinamas krovinų laikiklis
PL Uchwyt na bagażnik bazowy montowany na dachu
RU Грузовой багажник
UK Багажник для даху
BG Багажник, монтиран върху покрива
CS Nosič pro montáž na střeche
SK Strešný nosič
SL Nosilec za strešni prtljajnik
HR/BIH Krovni nosač tereta
RO Suport încărcătură montat pe acoperiș
HU Tetőre szerelhető csomagszállító

EL Σχήμα οροφής για μεταφορά φορτίου
TR Araç üstüne bağlanan yük taşıyıcı
HE גגון מטען לגג הארוב
AR حامل نقل مثبت على السقف
ZH 顶置行李架
JA ルーフマウント型ロードキャリア
KO 루프 장착 화물 캐리어
TH โครงยึดของบนรถทุกแบบติดตั้งบนหลังคา



CITY CRASH ISO 11154-E
Complies with ISO norm

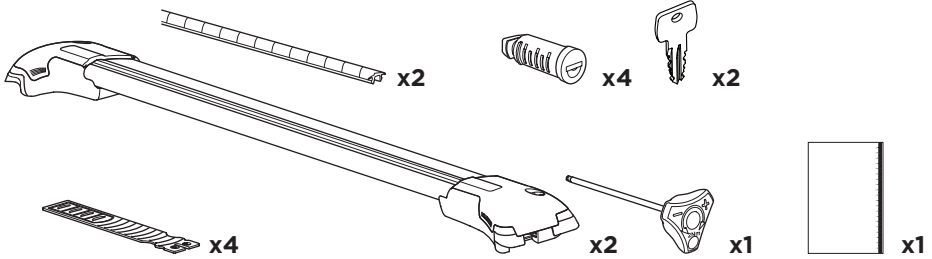
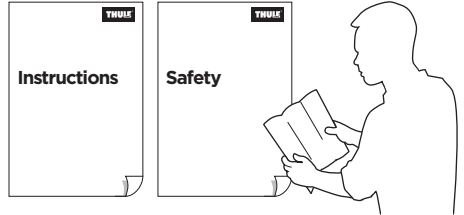

i

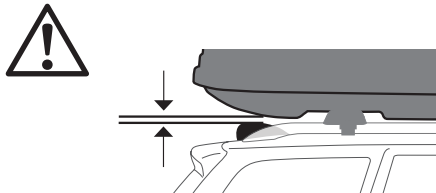
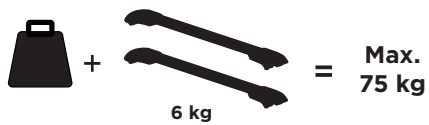
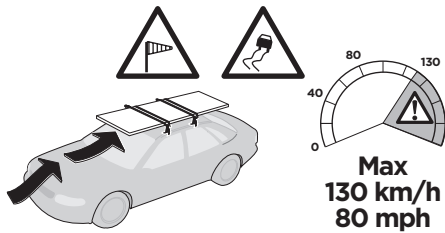
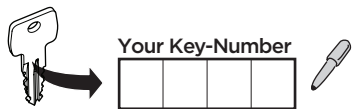

1

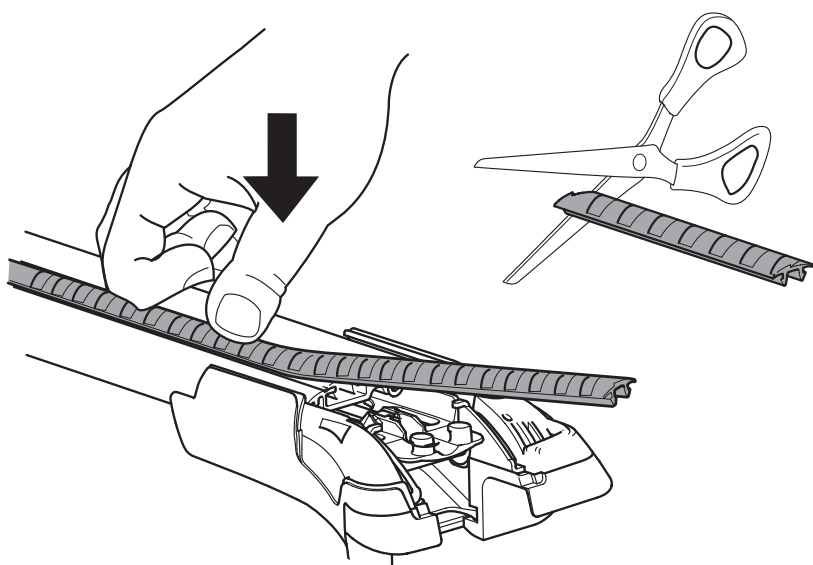
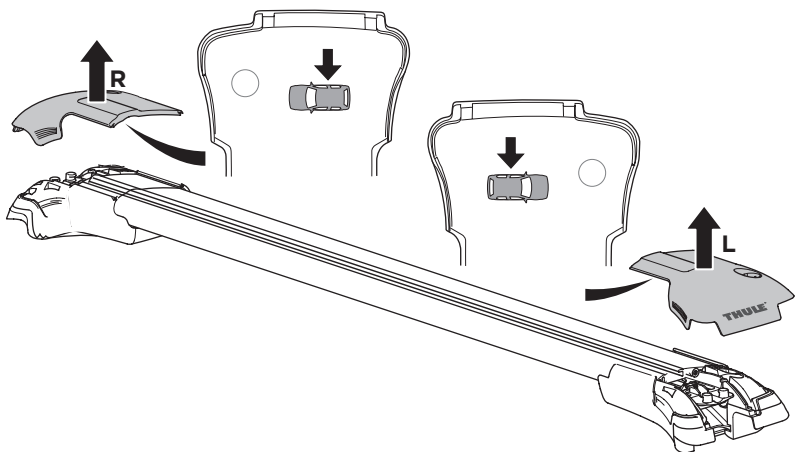
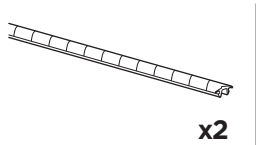

2



x2



x1

i

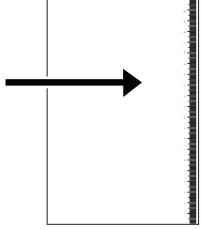
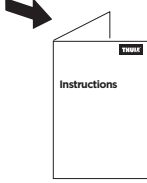

Rail	Hole
163-192 mm	4
135-163 mm	3
107-135 mm	2
79-107 mm	1

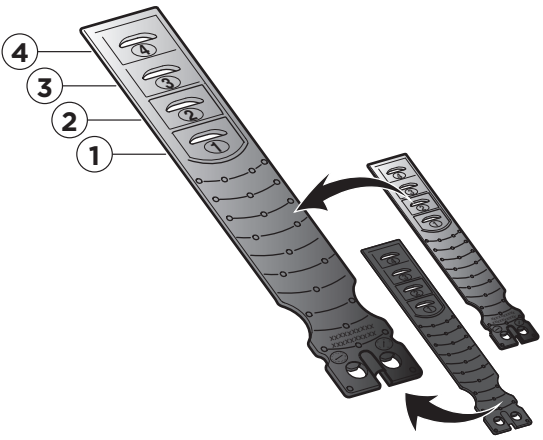
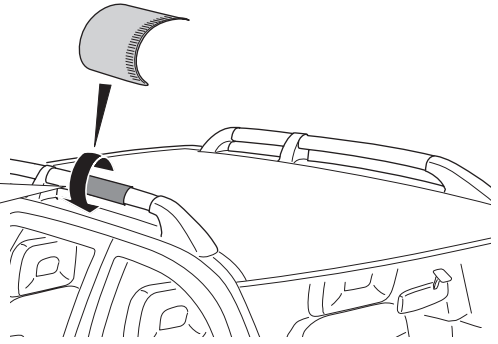

3

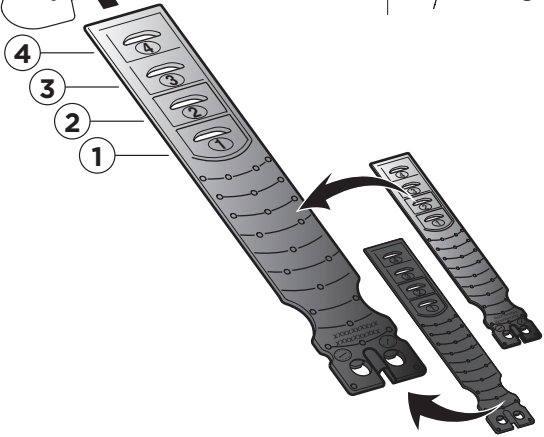
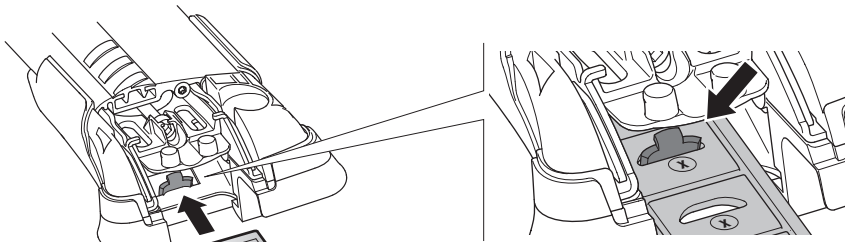
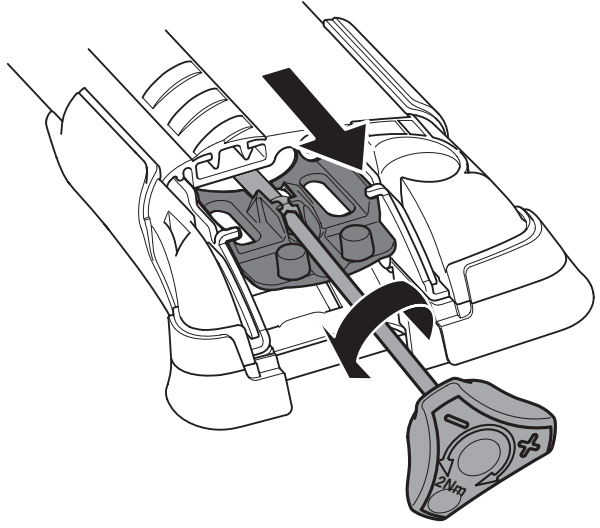
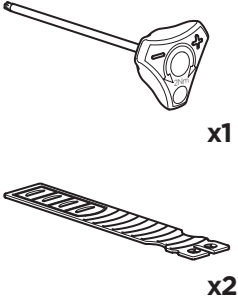

i

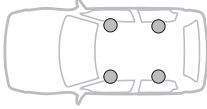

958100 / 958120
Wingbar Edge Rail S



958400 / 958420
Wingbar Edge Rail S/M



958200 / 958220
Wingbar Edge Rail M



958500 / 958520
Wingbar Edge Rail M/L

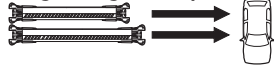

958300 / 958320
Wingbar Edge Rail L

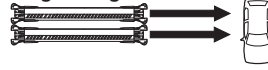

4

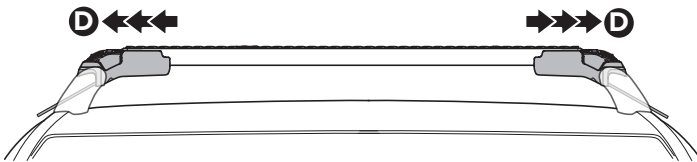
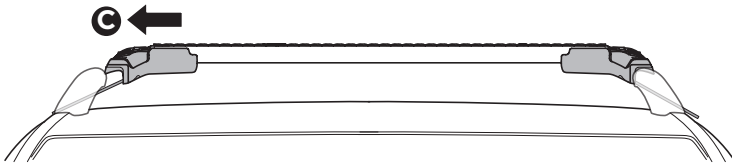
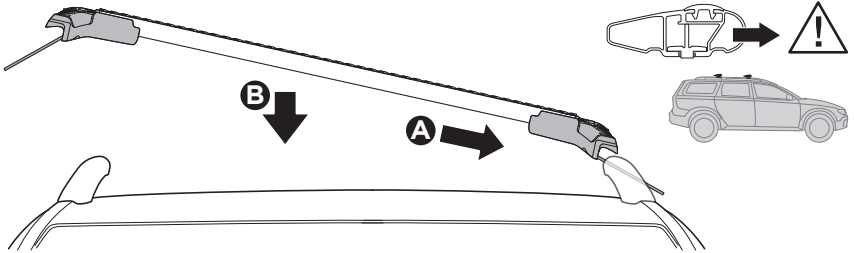

5

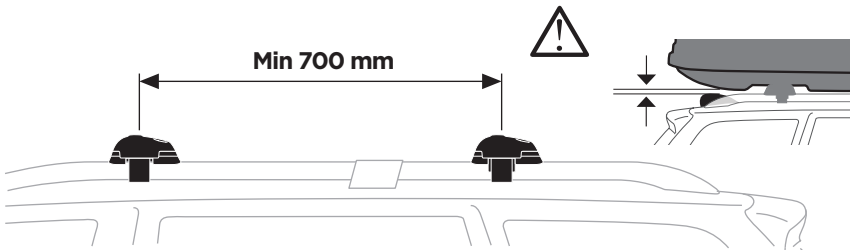

6

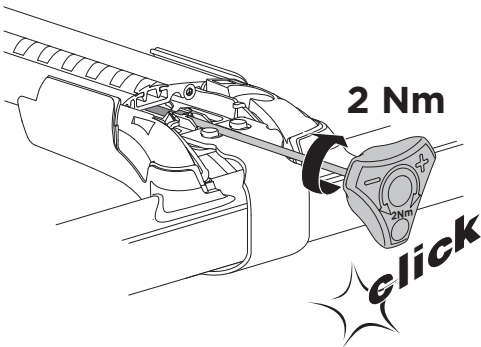
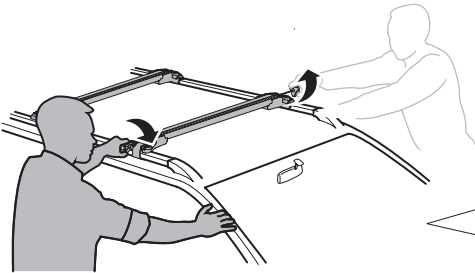
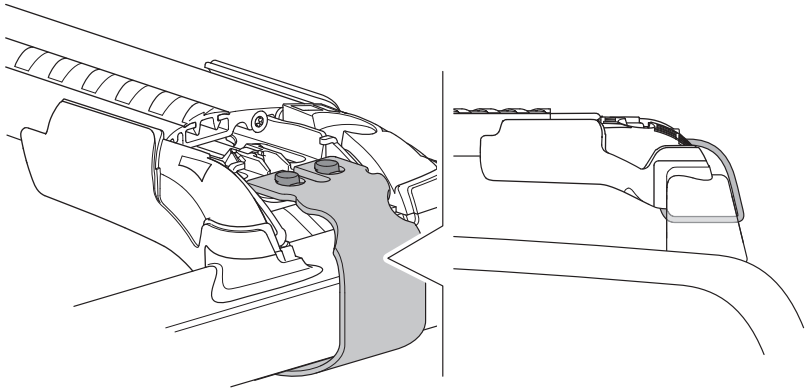

- EN** Tighten alternately
- DE** Die Schrauben abwechselnd anziehen
- FR** Serrer alternativement chaque côté
- NL** Afwisselend aan de linker- en de rechterkant aandraaien
- IT** Alternare il serraggio delle viti
- ES** Apretar alternativamente
- PT** Aperte alternadamente
- SV** Dra åt växelvis
- DK** Spænd skiftevis
- NO** Trekk til vekselvis
- FI** Kierrä vuorotellen
- ET** Pinguldage vaheldumisi
- LV** Pievelciet pamīšus
- LT** Užsukinėkite pakaitomis
- PL** Śruby dokręcaj naprzemiennie
- RU** Затягивайте попеременно
- UK** Затягти почергово
- BG** Затегнете последователно
- CS** Pokręťta багаžnika dokręcaj dokręcaj naprzemiennie.
- SK** Doťahujte striedavo
- SL** Privijajte izmenično
- HR/BiH** Naizmjenično zategnite
- RO** Strângeți alternativ
- HU** Egymástól függetlenül szorítandó
- EL** Σφίγγετε εναλλάξ
- TR** Dönüşümlü sıkın

إحكام الربط بالتناوب **AR**
 ἰσὴκ ὀσἰἰἰἰἰἰ **HE**

- ZH** 交替拧紧
- JA** 左右交互に締めつけてください
- KO** 번갈아 조이기
- TH** ۆἰἰἰἰἰἰἰἰἰἰ

7

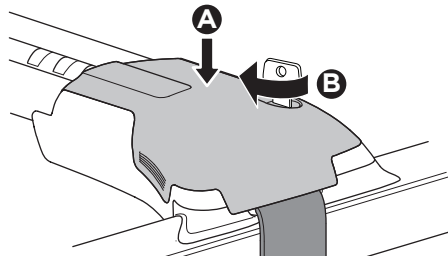
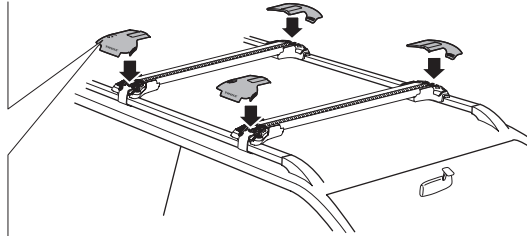
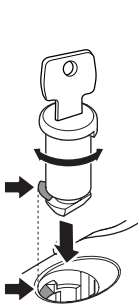
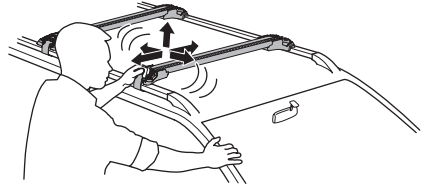

i

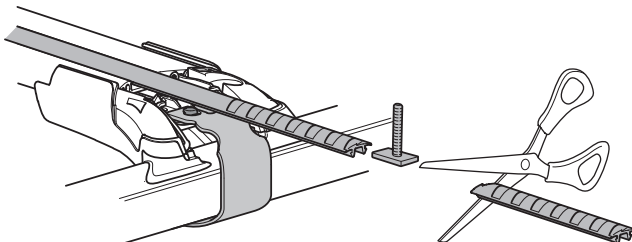
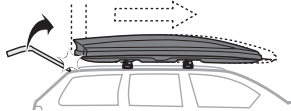

i

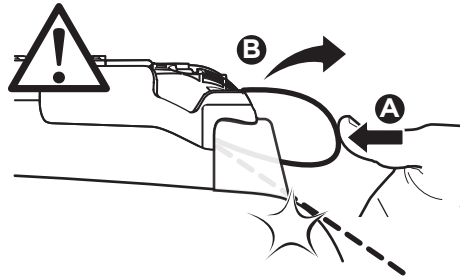
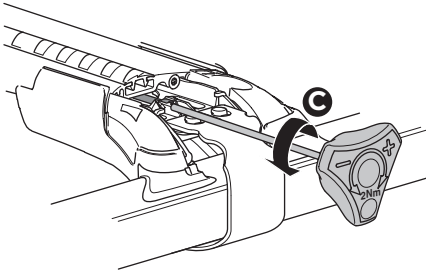
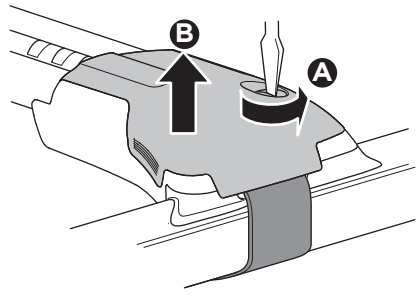
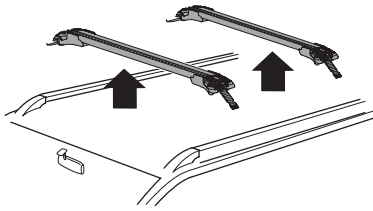

i

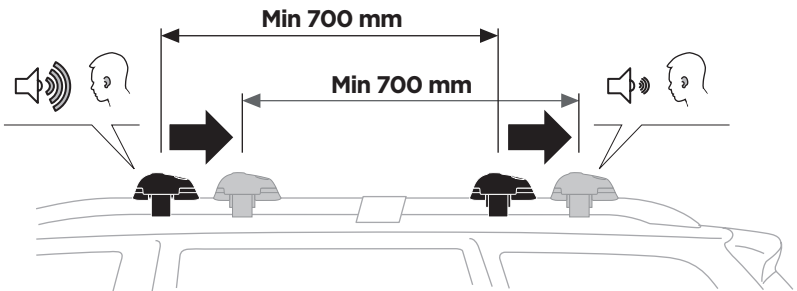

Thule One-Key System

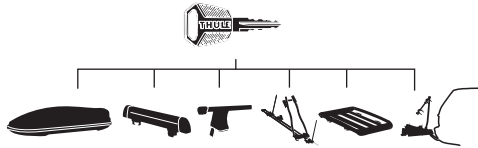

450400  (x4)

450600  (x6)

450800  (x8)

451200  (x12)

451600  (x16)

20
19
18
17
16
15
14
13
12
11
10
9
8
7
6
5
4
3
2
1

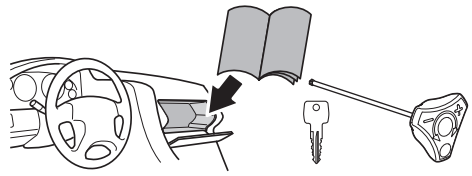

 Thule Sweden AB, Borggatan 5
335 73 Hillerstorp, SWEDEN

» PART OF THULE GROUP

 info@thule.com

© Thule Group 2019. All rights reserved.

 www.thule.com

501-7700-06