



2018 -

KIA Ceed estate

Cat. No. **K/071**

E20

E20 55R-01

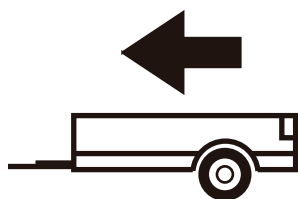

1500kg



75kg

D = 8,41kN

D (kN) =



MAX kg

x

MAX kg

x 0,00981



MAX kg

+

MAX kg



IMIOLA HAK-POL

96-111 KOWIESY, CHOJNATA 23A, POLAND

Tel. + 48 46 831 73 31, fax +48 831 74 29

e-mail: office@imiola.pl, www.imiola.pl



PRZEKRÓJ A-A



PL Należy zagwarantować przestrzeń swobodną według załącznika VII, rysunek 25a/b Regulaminu EKG ONZ 55.01 przy dopuszczalnym ciężarze całkowitym pojazdu.

F L'espace libre doit être garanti conformément à l'annexe VII, illustration de la réglementation 55.01 CE pour un poids total en charge autorisé du véhicule.







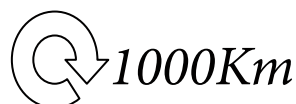

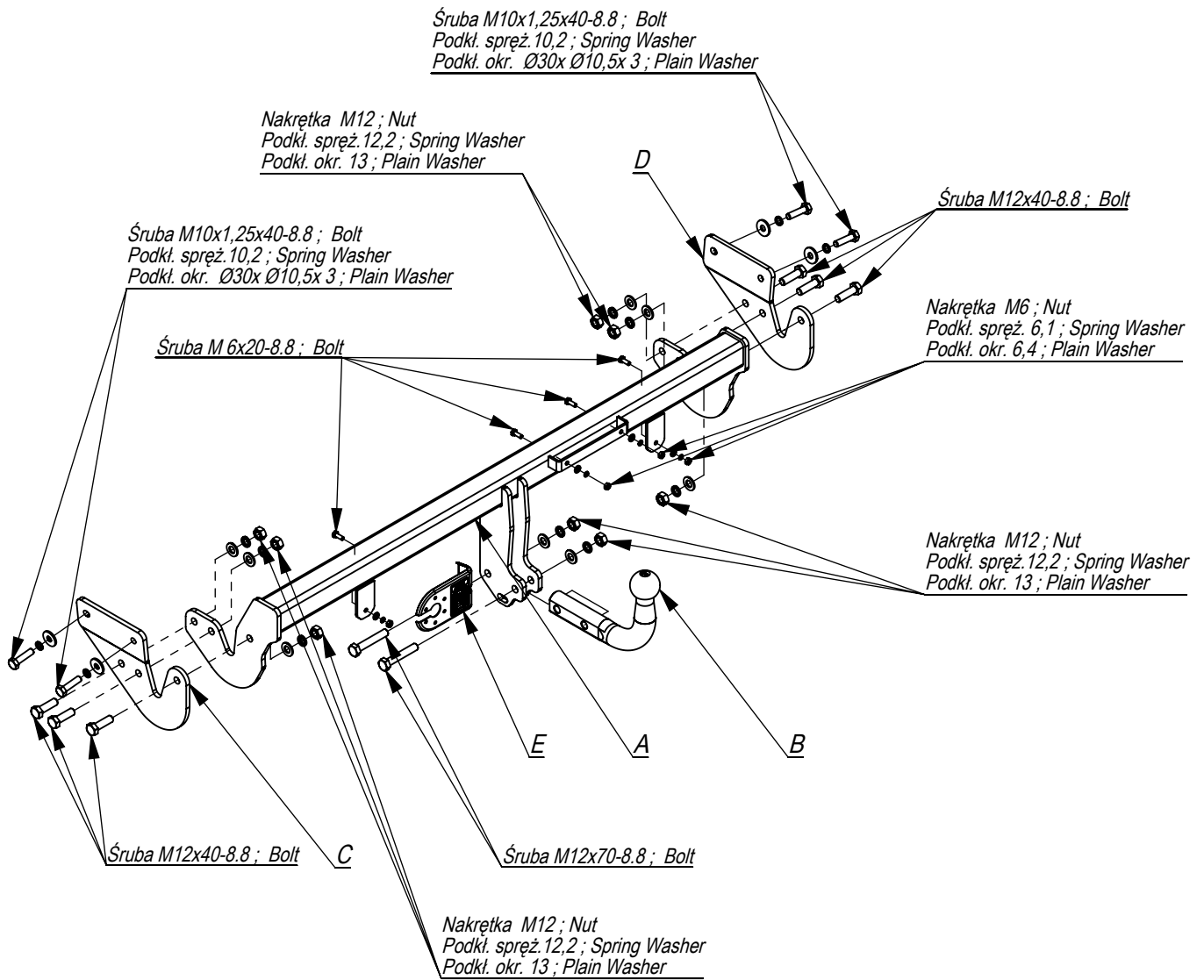
GB The clearance specified in appendix VII, diagram 25a/b of Regulation No. 55.01 UN EU must be guaranteed at laden weight of the vehicle.

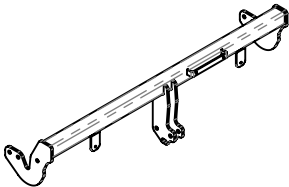
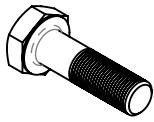
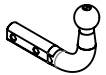
D Der Freiraum nach Anhang VII, Abbildung 25a/b der Vorschriften 55.01 EG ist zu gewährleisten bei zulässigem Gesamtgewicht des Fahrzeuges.

Moment skręcający dla śrub i nakrętek (8.8) Torque settings for nuts and bolts (8.8)	
M8	25Nm
M10	55Nm
M12	85Nm
M14	135Nm
M16	195Nm





	A	x1		M12x70	2
				M12x40	6
				M10x1,25x40	4
				M6x20	4
	B	x1		M12	8
	C	x1		Ø30xØ10,5x3	4
	D	x1		13	8
	E	x1		6,4	4
			12,2	8	
			10,2	4	
				6,1	4

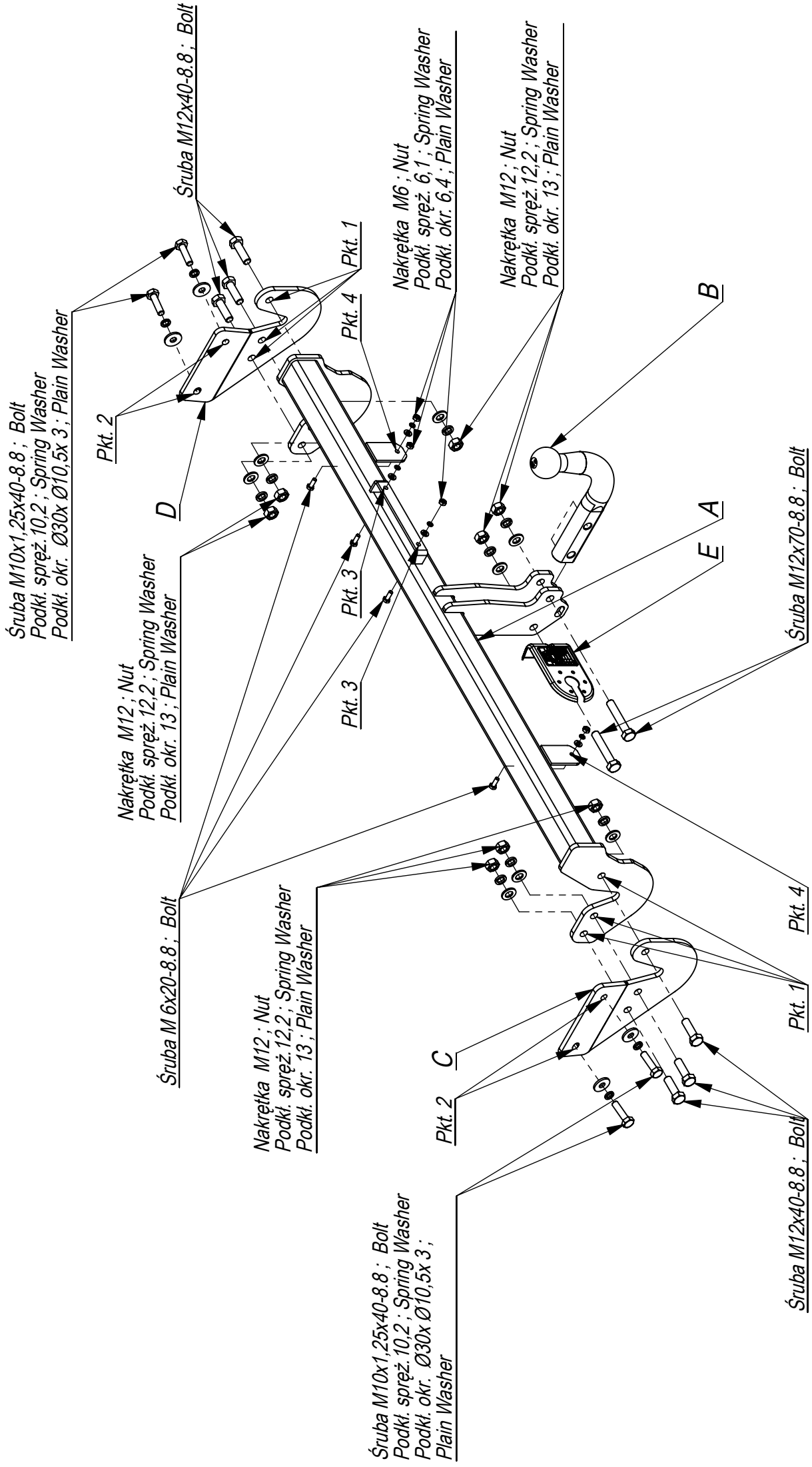

- Odkręcić zderzak i lampy.
- Udrożnić technologiczne otwory z gwintami w podłużnicach.
- Przykręcić elementy C i D do podłużnic śrubami M10x40x1,25 (pkt 2).
- Do elementów C i D przykręcić belkę zaczepu A śrubami M12x40 8.8 (pkt 1).
- Dokręcić wszystkie śruby z momentem wg tabeli.
- Wykonać w zderzaku wycięcie na uchwyt kuli.
- Założyć zderzak i lampy.
- Przykręcić kulę i blachę gniazda elektrycznego.
- Podłączyć instalację elektryczną.

- Unscrew the bumper and lamps.
- Clear the technological holes with the threads in the frame side members.
- Screw the elements C and D to the frame side members with bolts M10x40x1,25 (point 2).
- Screw the main bar A to the elements C and D with bolts M12x40 8.8 (point 1).
- Tighten all the bolts according to the torque setting- see the table.
- Assemble the bumper and lamps.
- Fix the ball and electric plate.
- Connect the electric wires.

- Dévissez les lampes, le pare-chocs et le renfort.
- Déboucher les fileté trous technologiques dans des longerons.
- Les éléments í crochets C et D doivent être vissé sur les longerons í l'aide de boulons M10x1,25x40 8.8 (point 2).
- Pour les éléments C et D, fixer l'attelage A avec les boulons M12x40 8.8. (point 1).
- Exécuter une encoche dans la partie inférieure du pare-chocs, pour l'encastrement de la boule.
- Serrer tous les boulons avec un couple de serrage selon tableau.
- Brancher l'installation électrique. Visser la boule et la tôle de la prise électrique.

- Die Rückleuchten, die Stoßstange abschrauben.
- Die Gewindebohrungen in den Längsträgern säubern.
- Die AHK-Bauteile C und D mit Schrauben M10x1,25x40 8.8 an den Längsträgern festschrauben (Punkt 2).
- Den AHK-Querträger A an die Bauteile C und D mit Schrauben M12x40 8.8 anschrauben (Punkt 1).
- Einen Ausschnitt im unteren Teil der Stoßstange, in ihrer Achse.
- Ziehen Sie alle Schrauben mit dem Drehmoment gemäß der Tabelle an.
- Die elektrische Installation anschließen.
- Die AHK-Kugel und die Steckdosenplatte festziehen.

- Desenrosque las lámparas, el parachoques.
- Limpiar los orificios tecnológicos roscada en los largueros.
- Fijar los elementos C y D del gancho a los largueros con tornillos M10x1,25x40, 8.8 (punto 2)
- Atrnillar la viga de la bola de remolque A a los elementos C y D usando tornillos M12x40 8.8 (punto 1).
- Cortar la parte inferior del parachoques, en su eje, para una abertura para el soporte del balón.
- Apretar todos los tornillos con el par según la tabla anterior.
- Apretar la bola y la placa de la toma eléctrica.
- Conectar la instalación eléctrica.

