



# TOYOTA

## Highlander

2021 -

Cat. No. T/078

E20

E20 55R-02

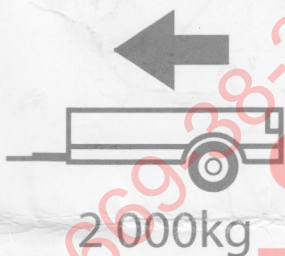

D = 11,90kN

D (kN) =



MAX kg

x

MAX kg

x 0,00981

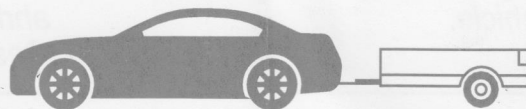

MAX kg

+

MAX kg

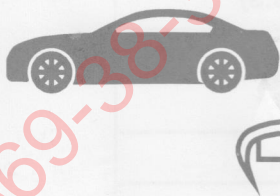

IMIOLA HAK-POL

96-111 KOWIESY, CHOJNATA 23A, POLAND

tel. +48 46 831 73 31, fax +48 831 74 29

e-mail: office@imiola.pl, www.imiola.pl



Rys. 25a

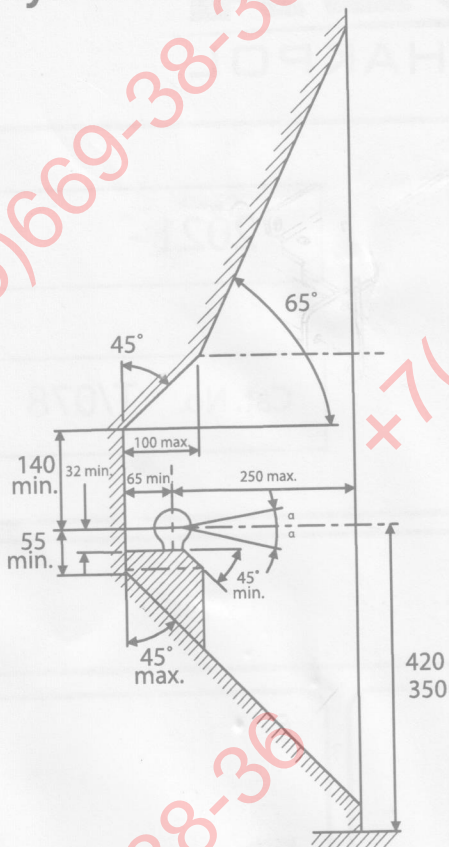

Rys. 25b

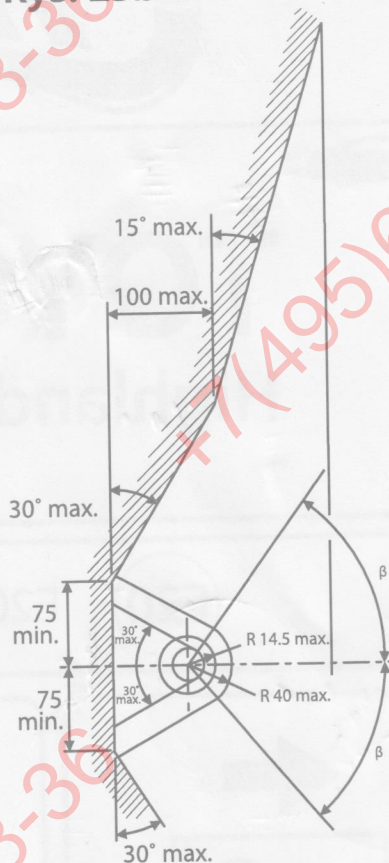

ФАРКОП.РФ

PL

Należy zagwarantować przestrzeń swobodną według załącznika VII, rysunek 25a/b Regulaminu EKG ONZ 55.02 przy dopuszczalnym ciężarze całkowitym pojazdu.

FR

L'espace libre doit être garanti conformément à l'annexe VII, illustration de la règlement 55.02 CE pour un poids total en charge autorisé du véhicule.

GB

The clearance specified in appendix VII, diagram 25a/b of Regulation No. 55.02 UN EU must be guaranteed at laden weight of the vehicle.

DE

Der Freiraum nach Anhang VII, Abbildung 25a/b der Vorschriften 55.02 EG ist zu gew 25a/bahrleiten bei zulässigem Gesamtgewicht des Fahrzeuges.

Moment skręcający dla śrub i nakrętek (8.8)  
Torgue settings for nuts and bolts (8.8)

M8	25Nm
M10	55Nm
M12	85Nm
M14	135Nm
M16	195Nm





Śruba M12x1,25x35-8.8 ; Bolt  
 Podkł. spręż. 12,2 ; Spring Washer  
 Podkł. okr. Ø36x Ø13x 3 ; Plain Washer

Śruba M12x1,25x35-8.8 ; Bolt  
 Podkł. spręż. 12,2 ; Spring Washer  
 Podkł. okr. Ø36x Ø13x 3 ; Plain Washer

Śruba M12x1,25x35-8.8 ; Bolt  
 Podkł. spręż. 12,2 ;  
 Spring Washer  
 Podkł. okr. Ø36x Ø13x 3 ;  
 Plain Washer

Nakrętka M12 ; Nut  
 Podkł. spręż. 12,2 ; Spring Washer  
 Podkł. okr. 13 ; Plain Washer





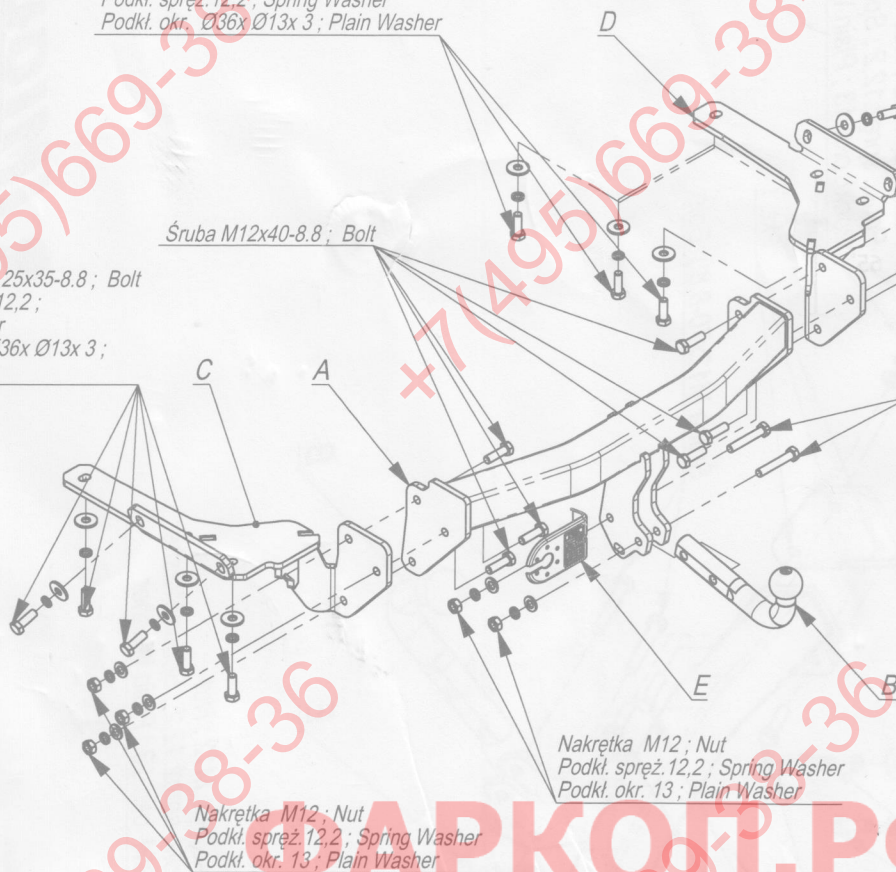



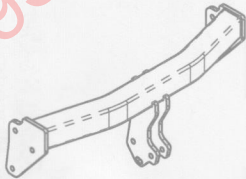

Śruba M12x40-8.8 ; Bolt

Śruba M12x70-8.8 ; Bolt



Nakrętka M12 ; Nut  
 Podkł. spręż. 12,2 ; Spring Washer  
 Podkł. okr. 13 ; Plain Washer

+7 (495) 669-38-36

	A	x1		M12x70	2
	B	x1		M12x40	6
	C	x1		M12x1,25x35	10
	D	x1		M12	8
	E	x1		Ø36xØ13x3	10
				13	8
				12,2	18



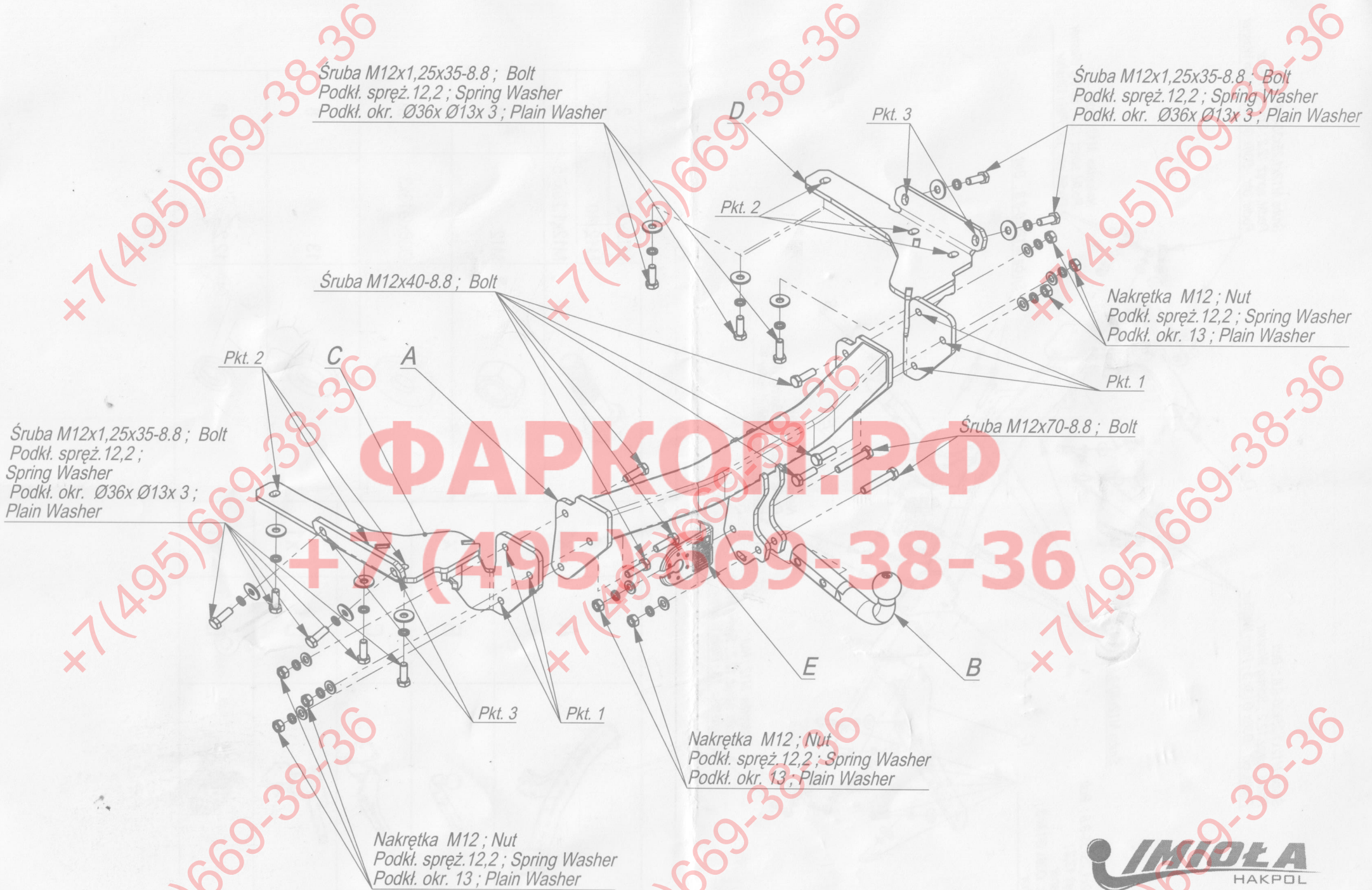

Nr katalogowy  
T/078

Marka  
Toyota Highlander od 2021 - >



96-111 Kowiesy, Chojnata 23 A  
tel. +48 46 831 73 31



