



Инструкция по установке  
**Toyota Land Cruiser 200**  
(2007-)



Арт.: F.5713.006

 <b>2500 kg</b>	 <b>120 kg</b>	<b>D = 14,04 kN</b>	
---	--	---------------------	---

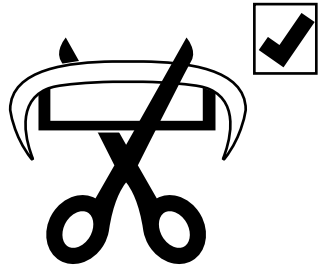
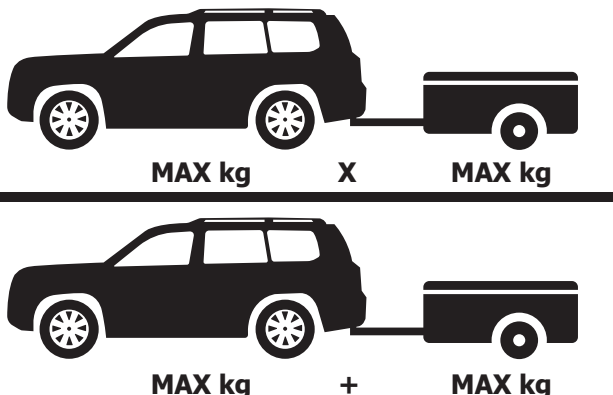
<b>D (kN) =</b>	 <b>MAX kg X MAX kg</b> <b>MAX kg +</b>	<b>x 0,00981</b>
-----------------	---	------------------

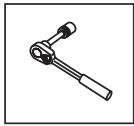

Вкрутить/выкрутить используя инструмент

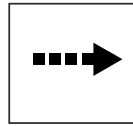

Движение

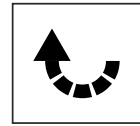

Поворот



Вкрутить/выкрутить не затягивая

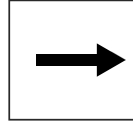





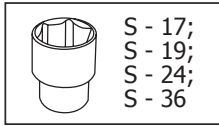
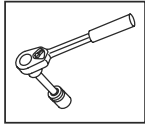



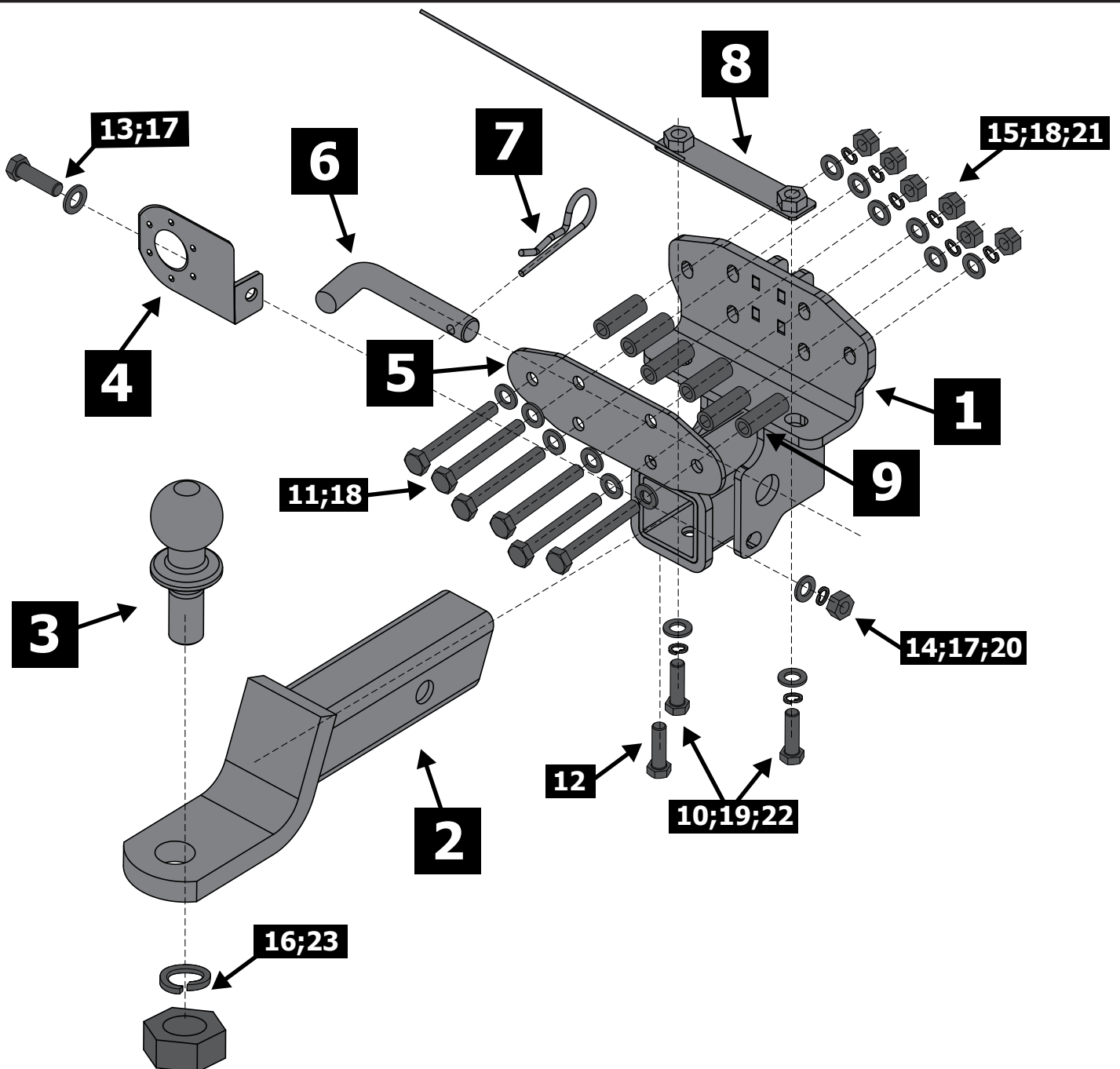
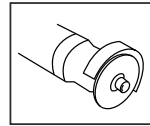
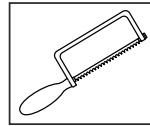
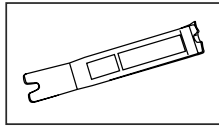





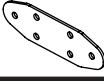
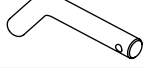

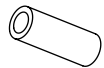
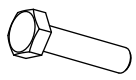
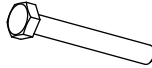

Расположение

### Используемый инструмент:

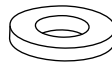

S - 17;  
S - 19;  
S - 24;  
S - 36



<b>1</b>	x1	Кронштейн	
<b>2</b>	x1	Адаптер	
<b>3</b>	x1	Шар	
<b>4</b>	x1	Подрозетник	
<b>5</b>	x1	Пластина прижимная	
<b>6</b>	x1	Штифт	
<b>7</b>	x1	Шплинт пружинный	
<b>8</b>	x1	Гайка закладная	
<b>9</b>	x6	Втулка	
<b>10</b>	x2	M16x60	
<b>11</b>	x6	M12x110	
<b>12</b>	x1	M10x20	
<b>13</b>	x1	M10x30	
<b>14</b>	x1	M10	
<b>15</b>	x6	M12	
<b>16</b>	x1	M24	
<b>17</b>	x2	Ø10	
<b>18</b>	x12	Ø12	
<b>19</b>	x2	Ø16	
<b>20</b>	x1	Ø10	
<b>21</b>	x6	Ø12	
<b>22</b>	x2	Ø16	
<b>23</b>	x1	Ø24	

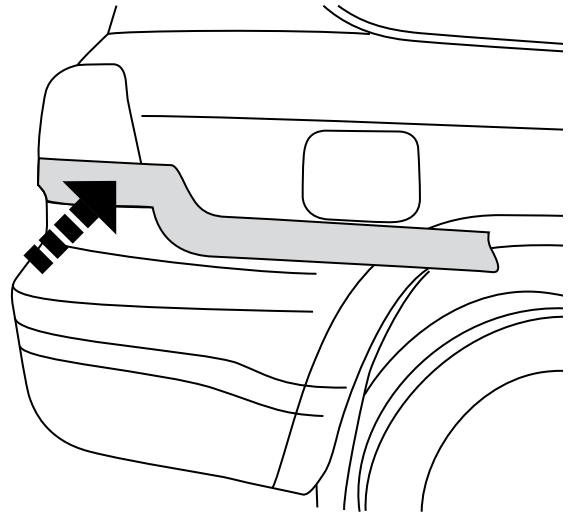
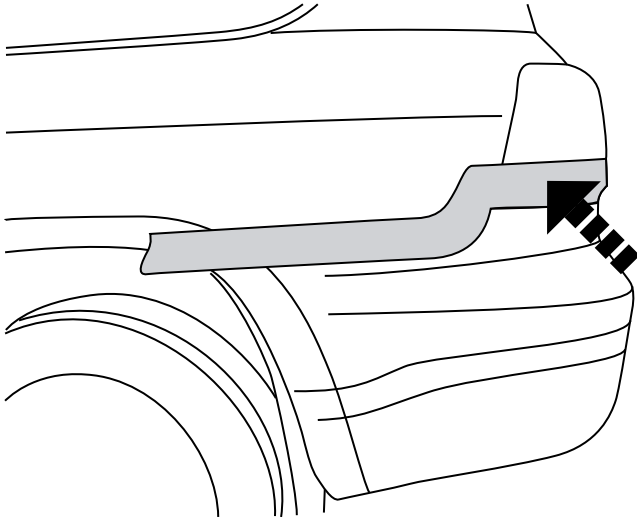
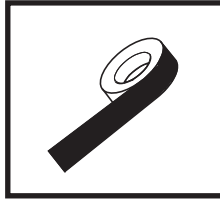
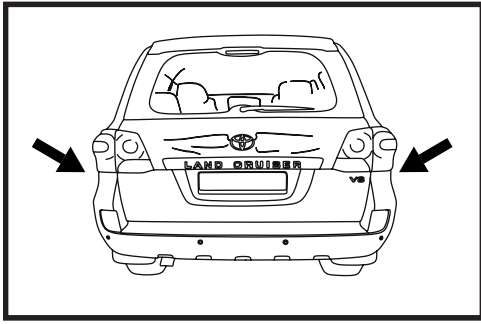

**1**

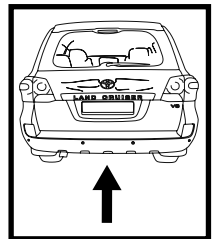
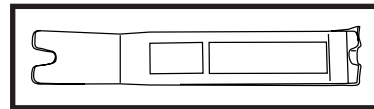
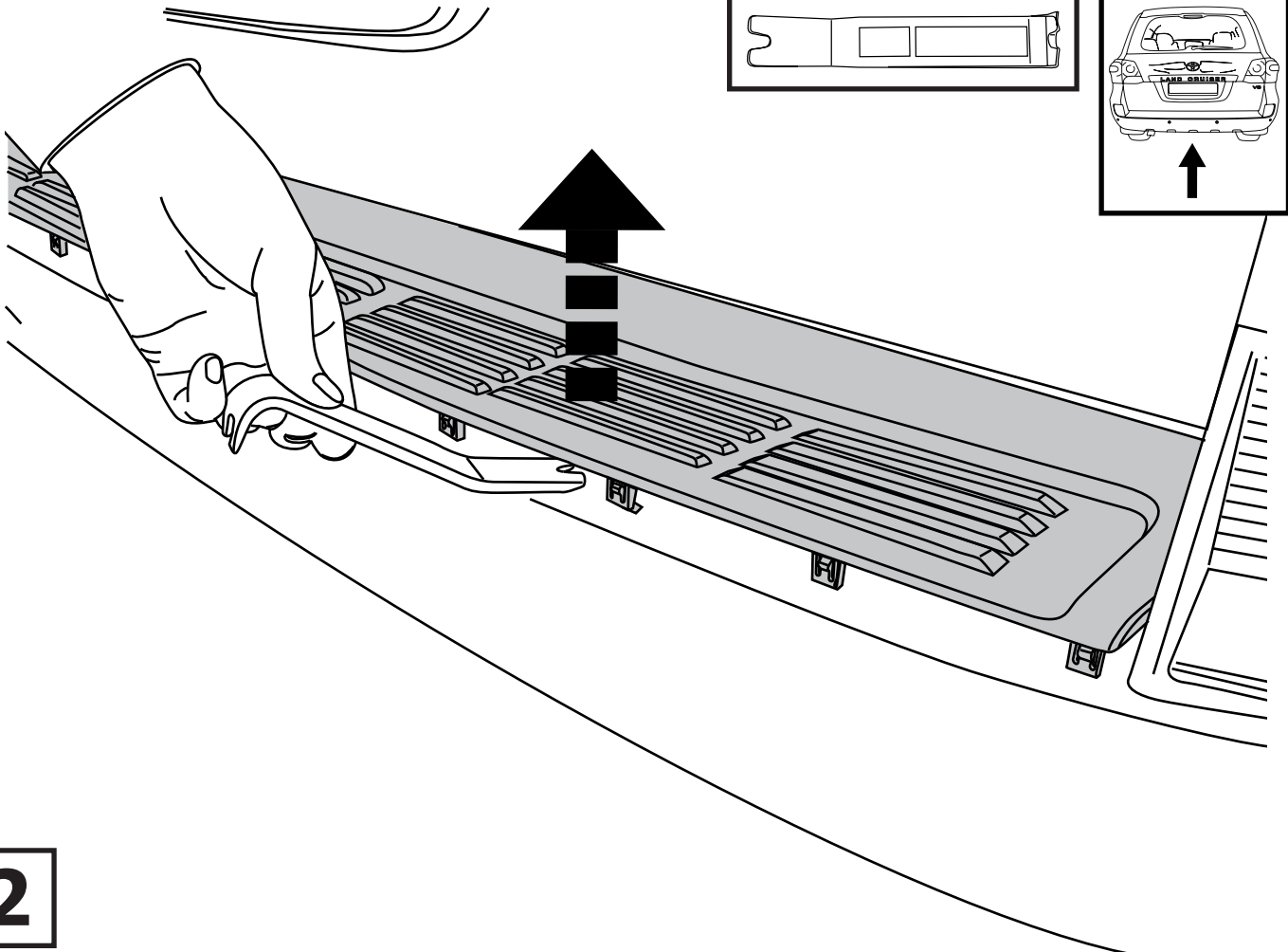

**2**

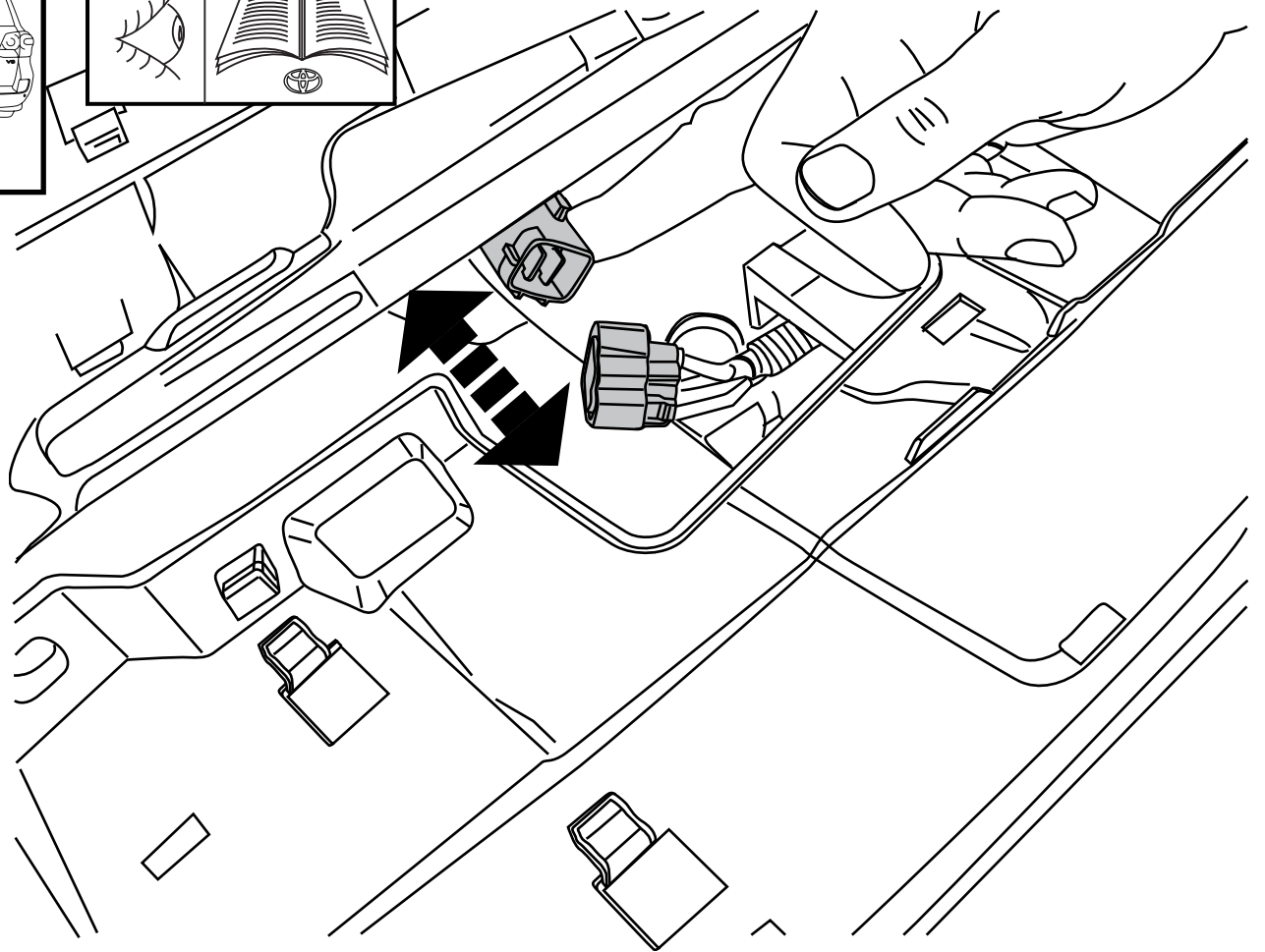
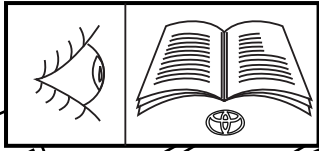
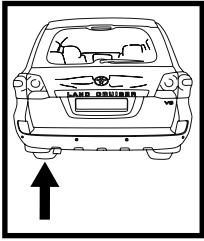

**3**

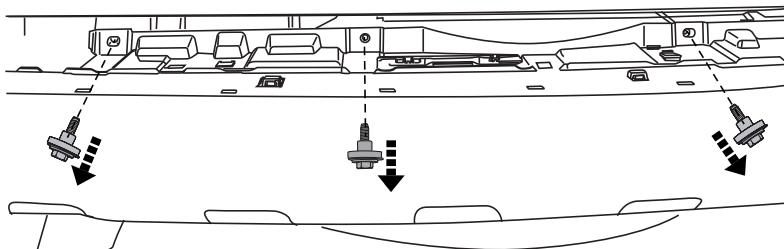
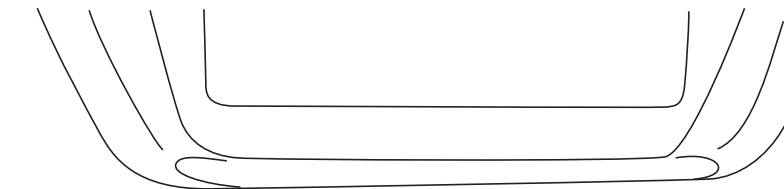
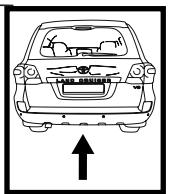
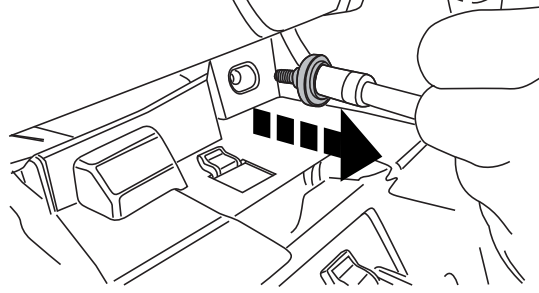
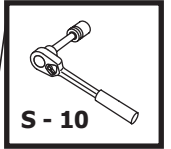
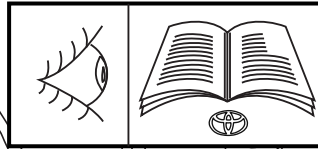
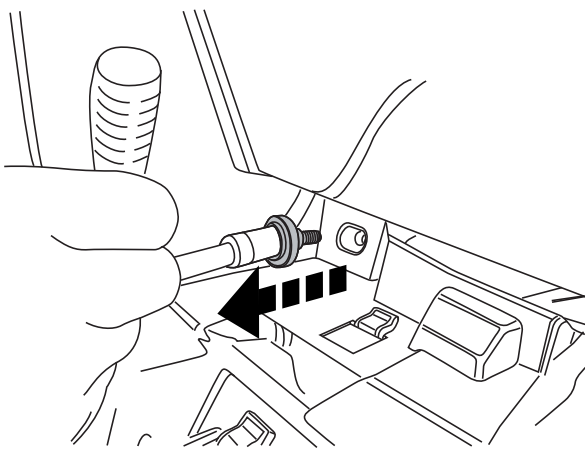

**4**

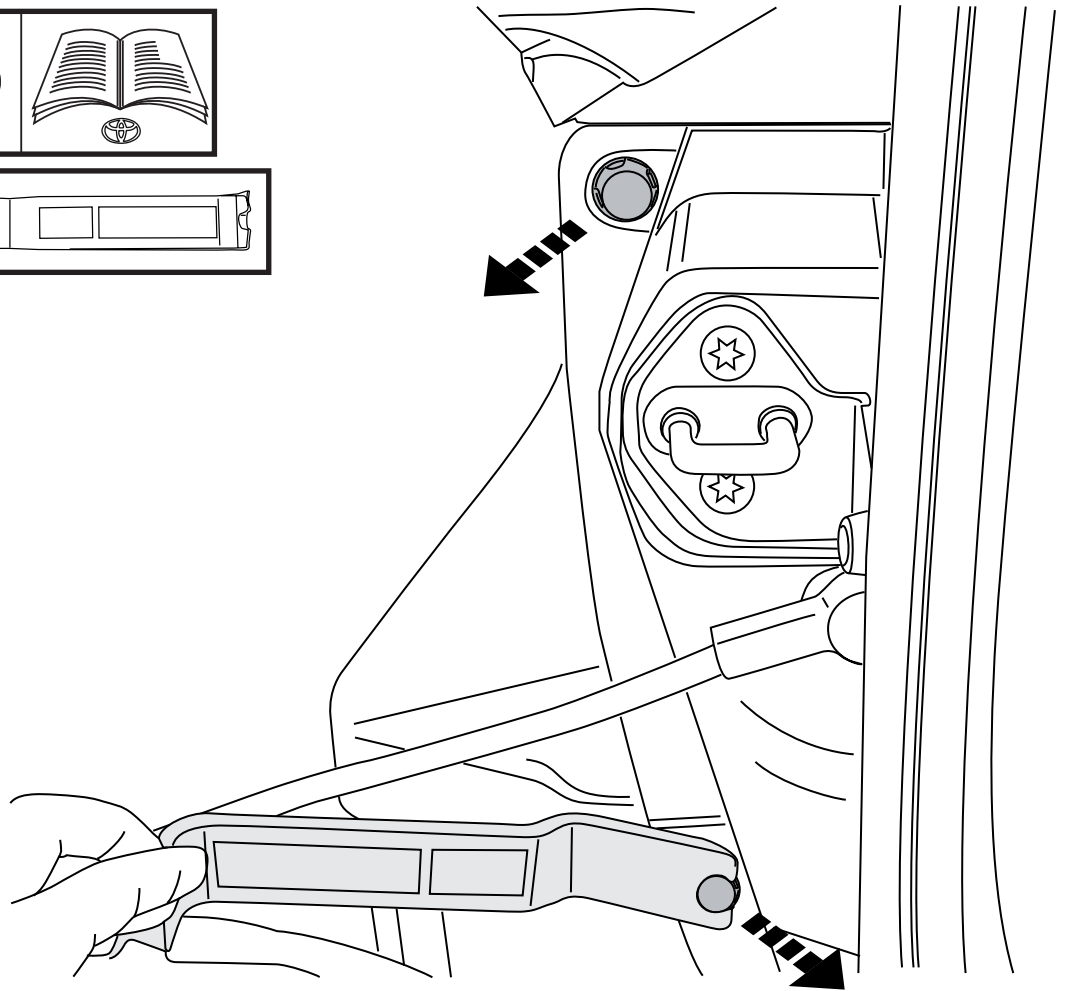
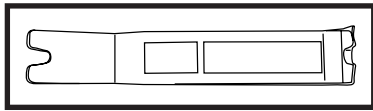
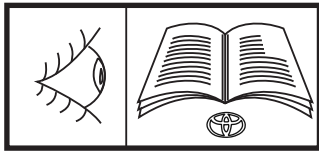
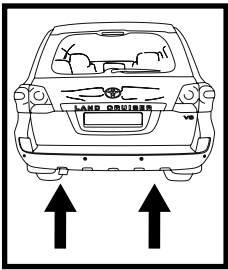

**5**

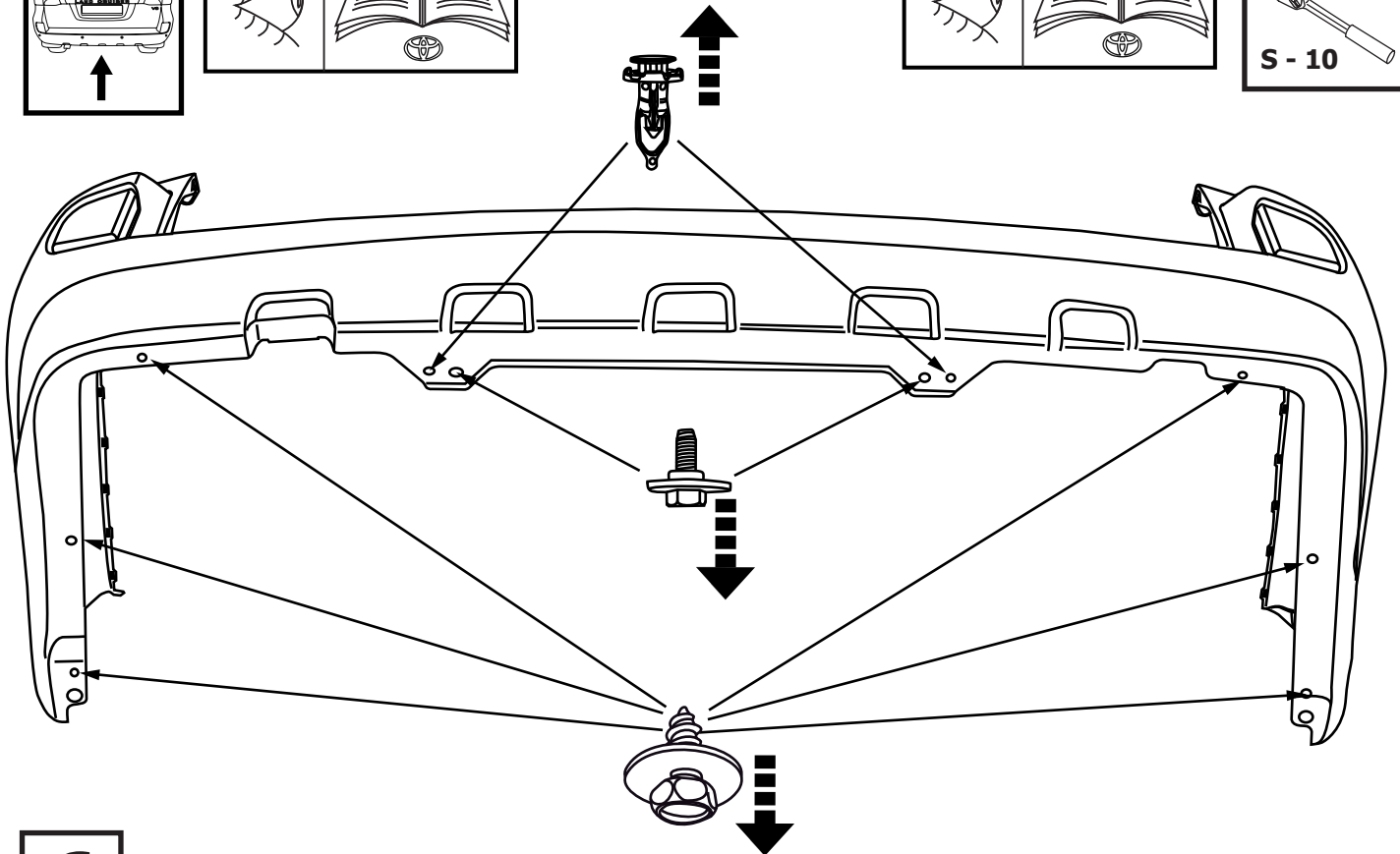
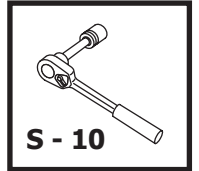
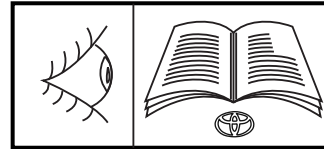
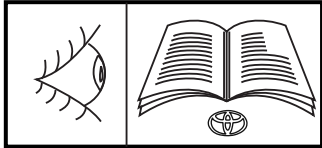
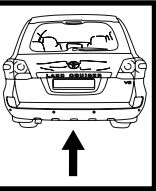

**6**

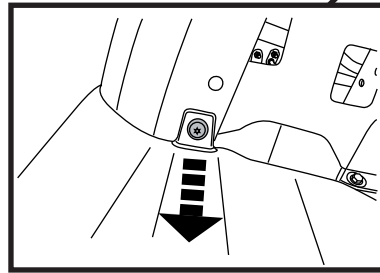
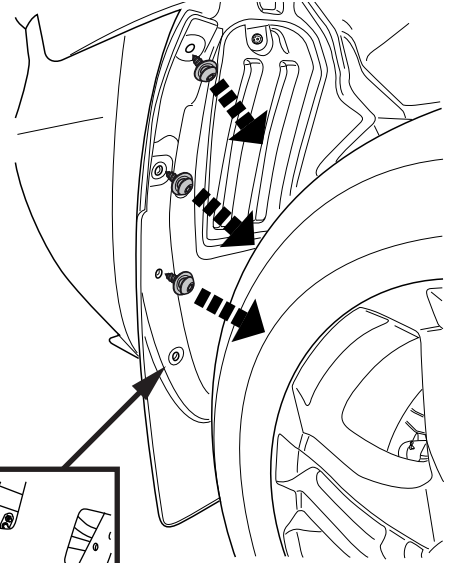
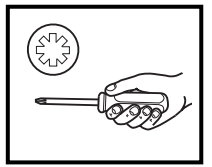
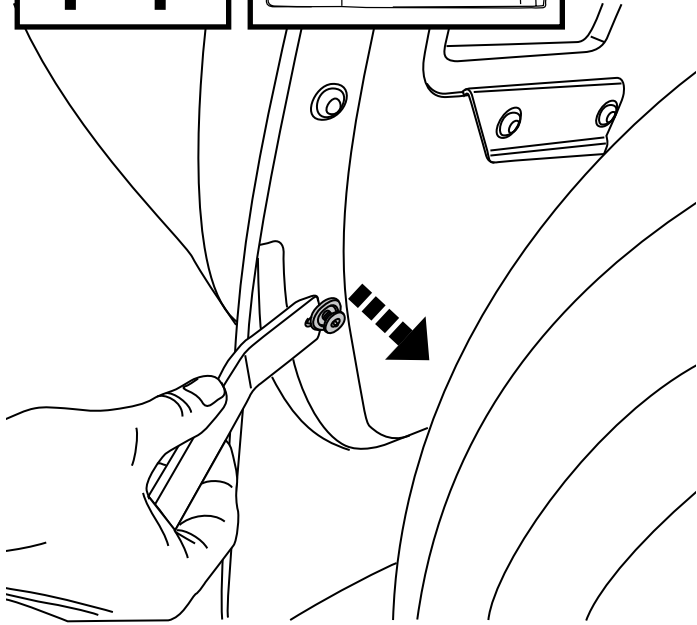
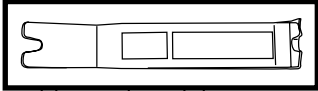
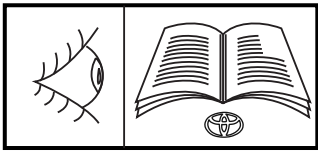
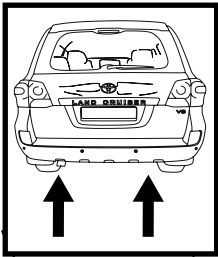

7

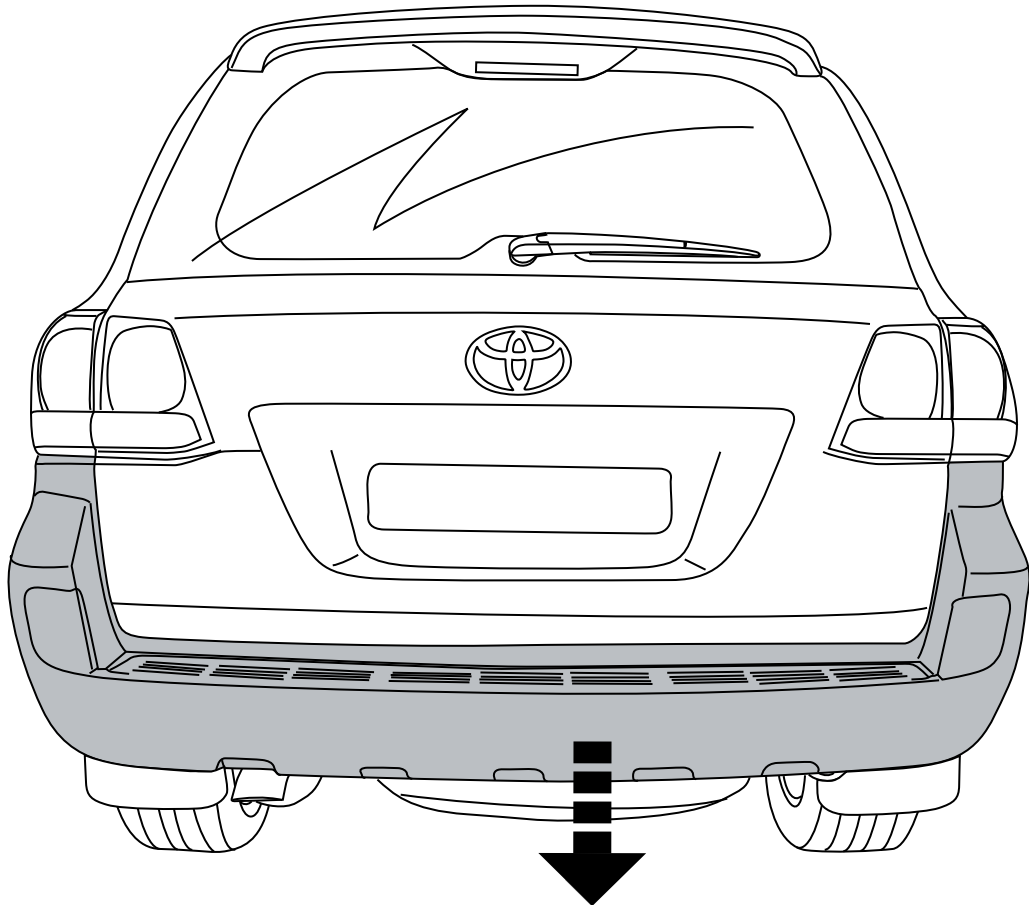

8

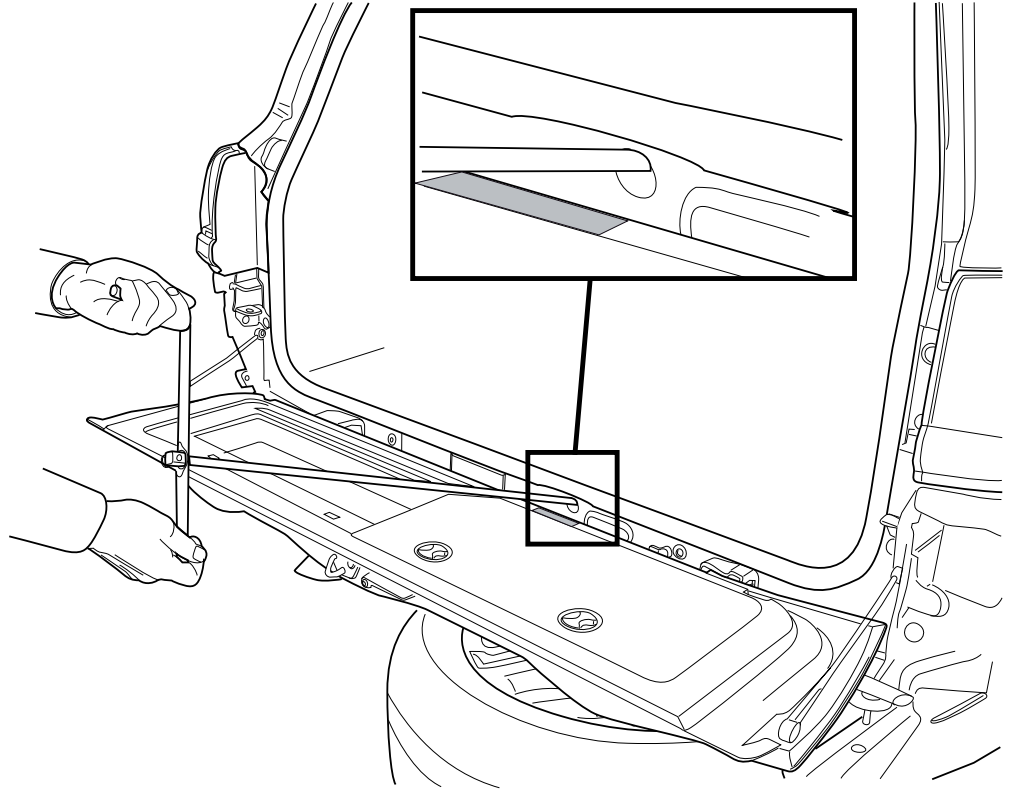
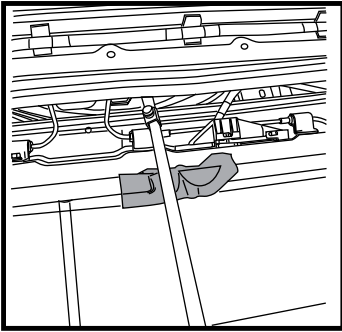
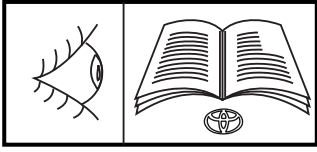
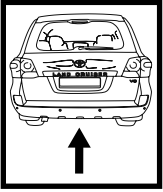

**9**

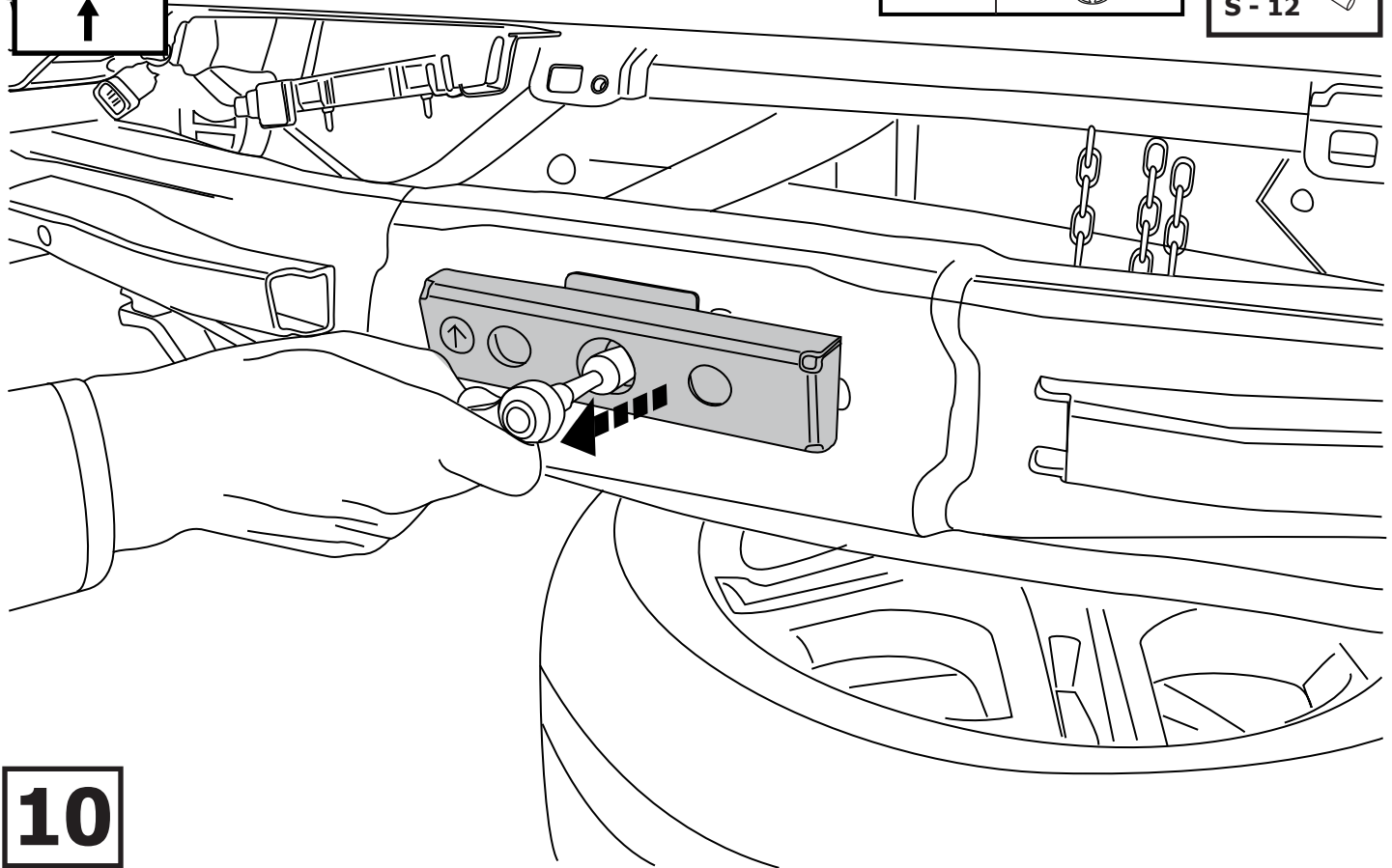
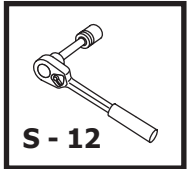
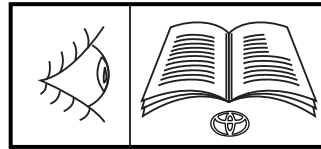
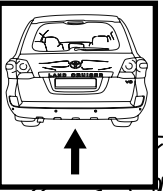

**10**



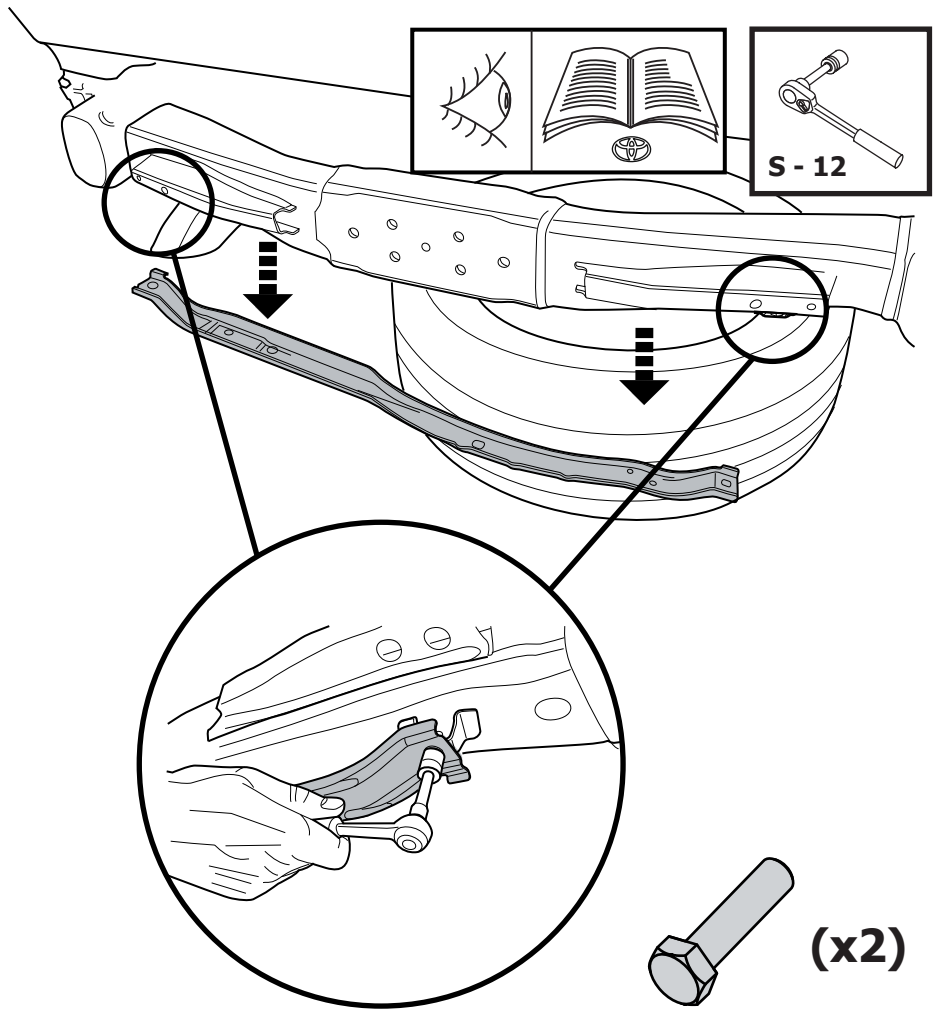
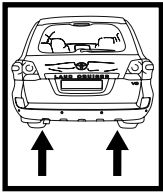

**11**

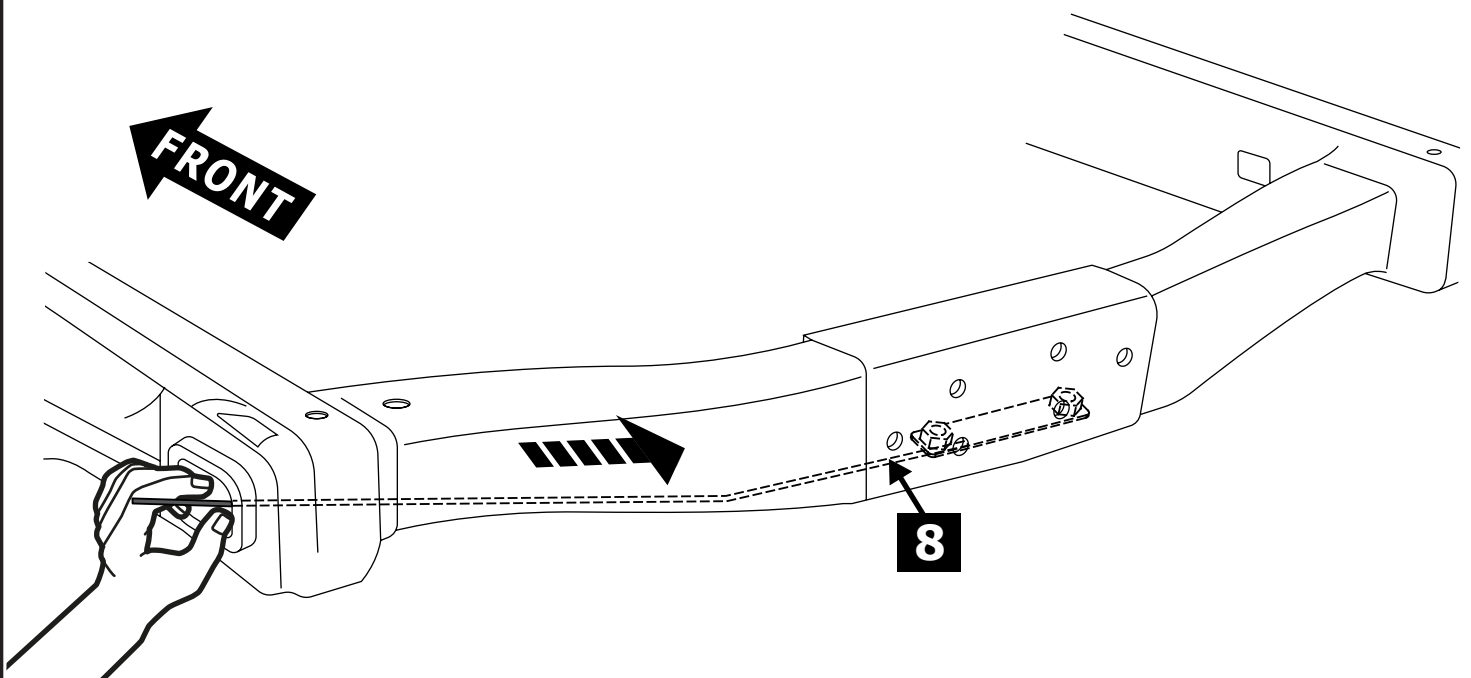

**12**

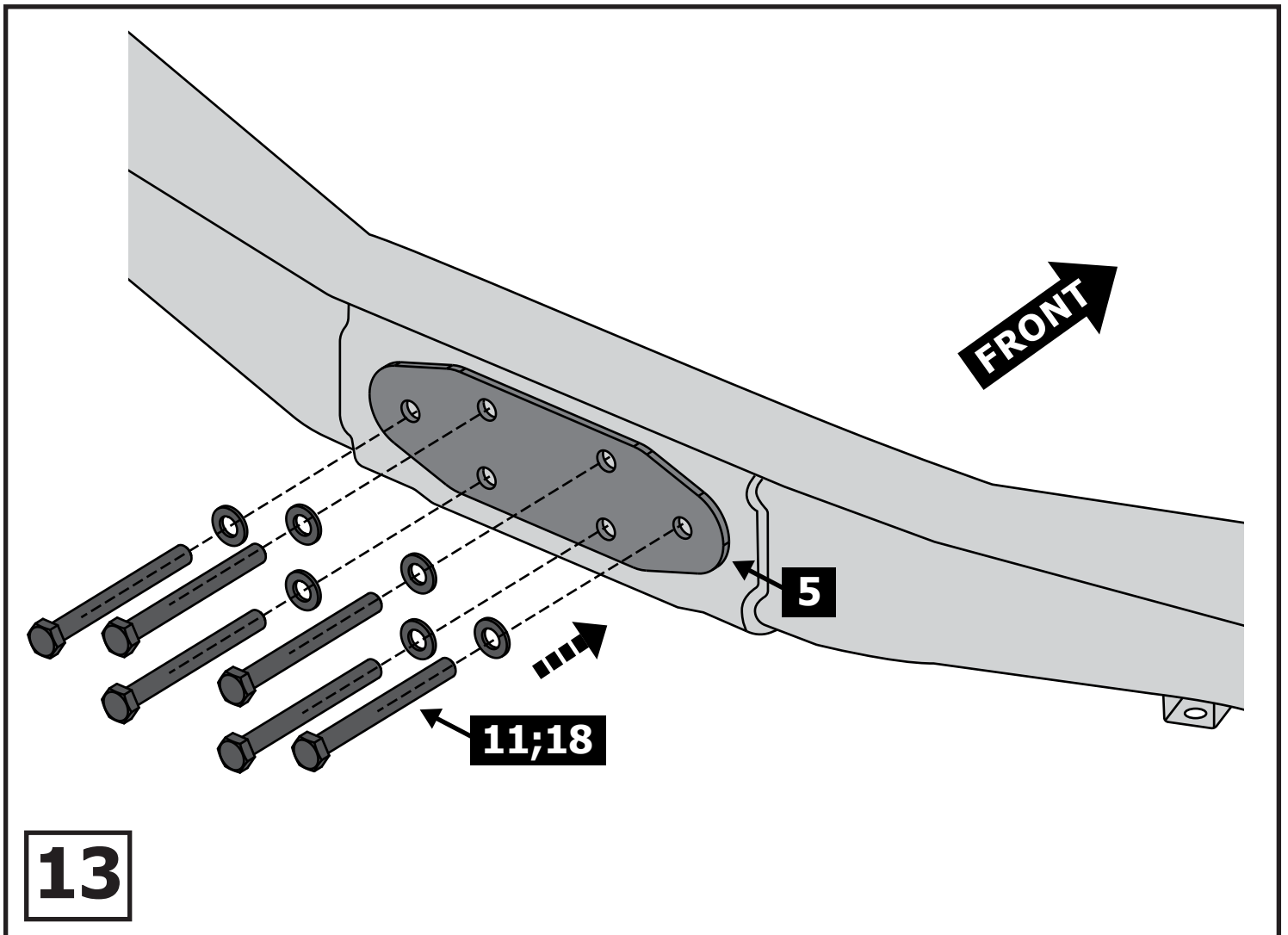

**13**

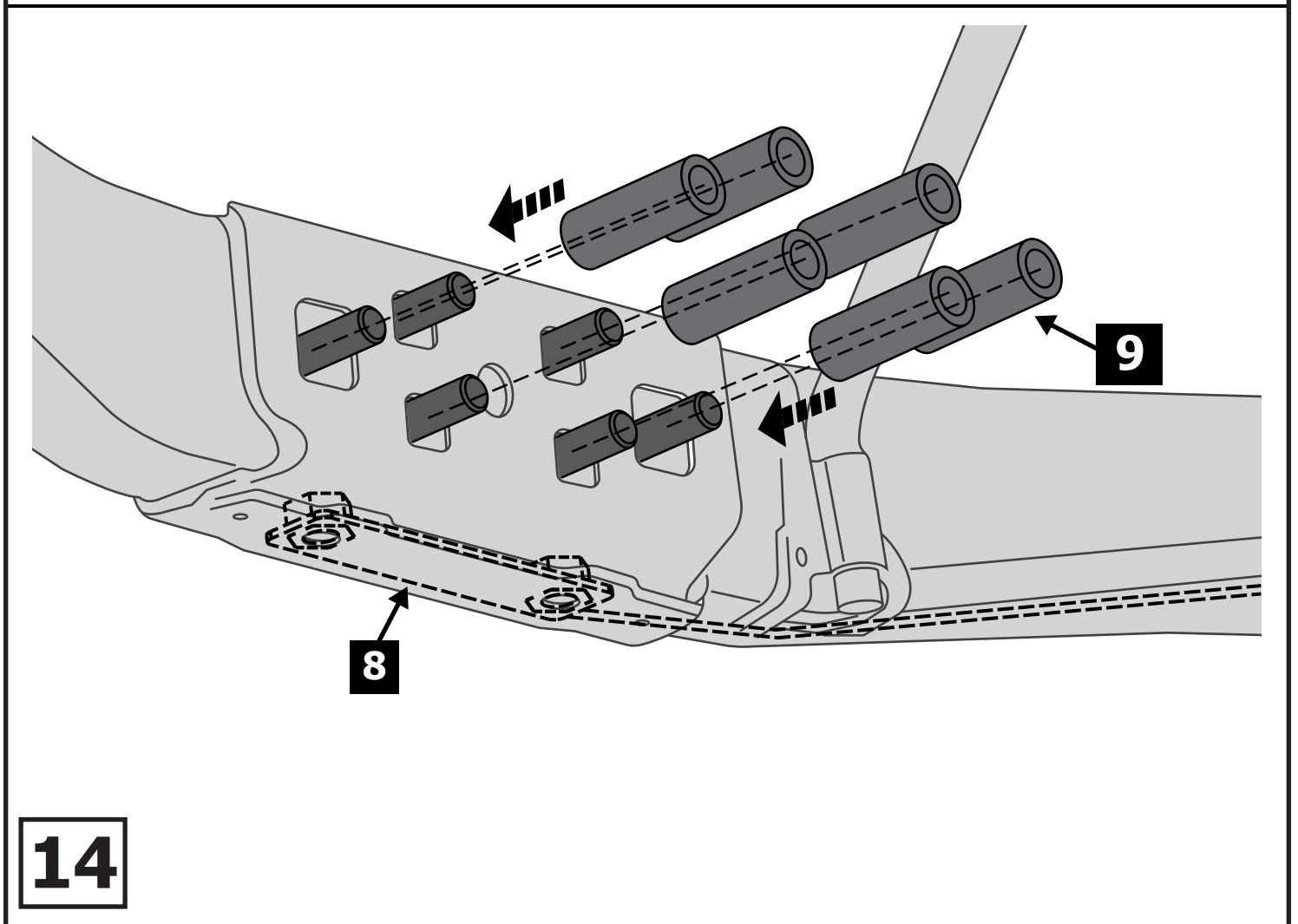

**14**

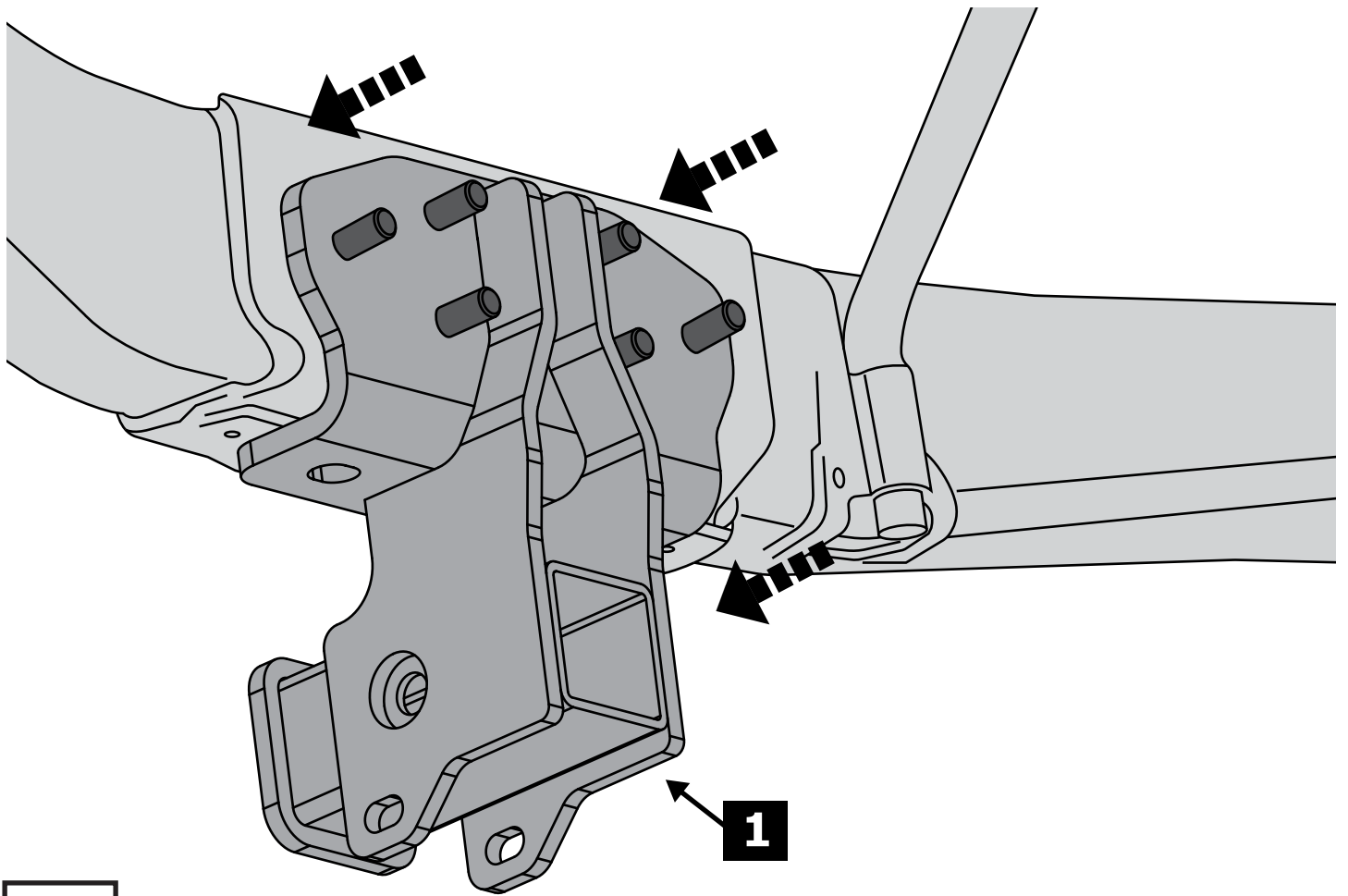

**15**

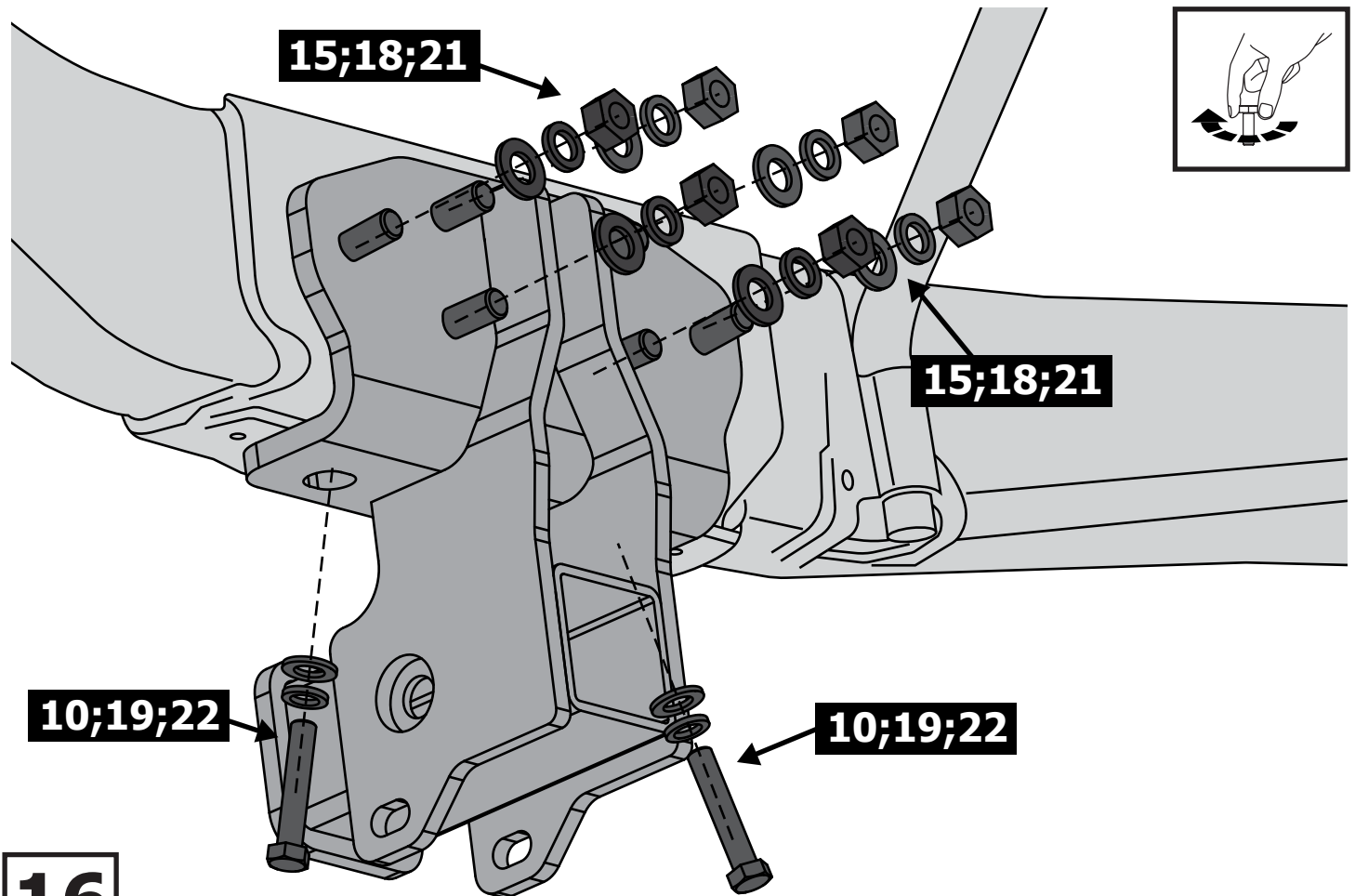

**16**

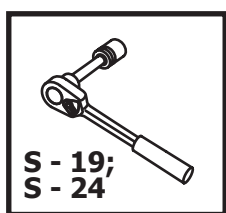
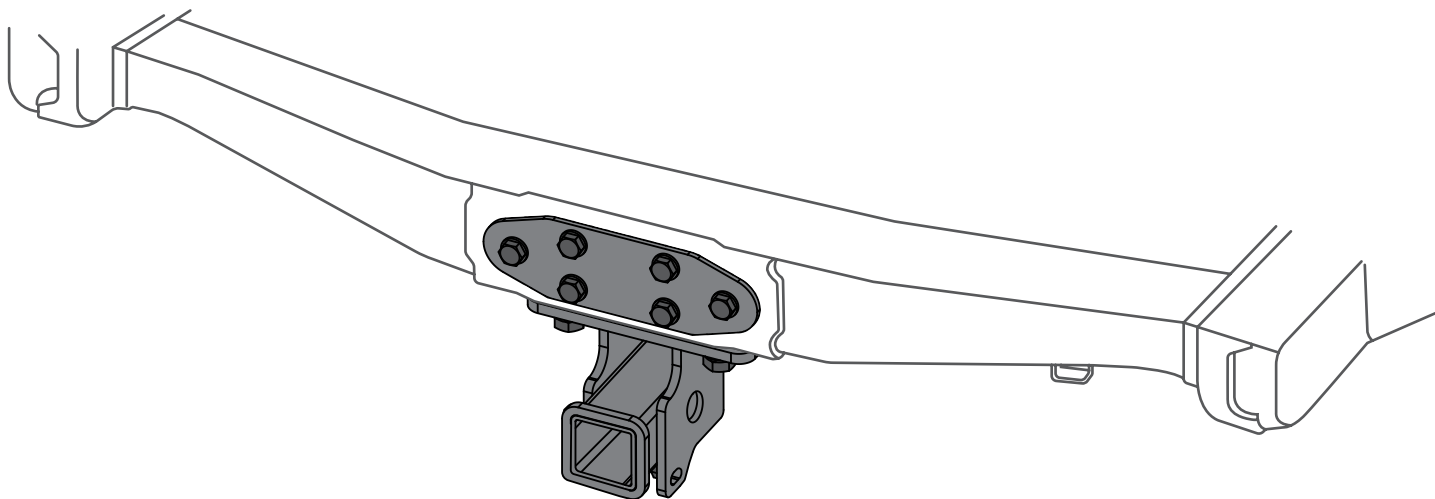

**Затянуть все резьбовые соединения  
в указанном порядке:**

- 1. M16 = 157 Nm**
- 2. M12 = 81 Nm**

**17**

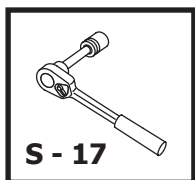

**M10 = 50 Nm**

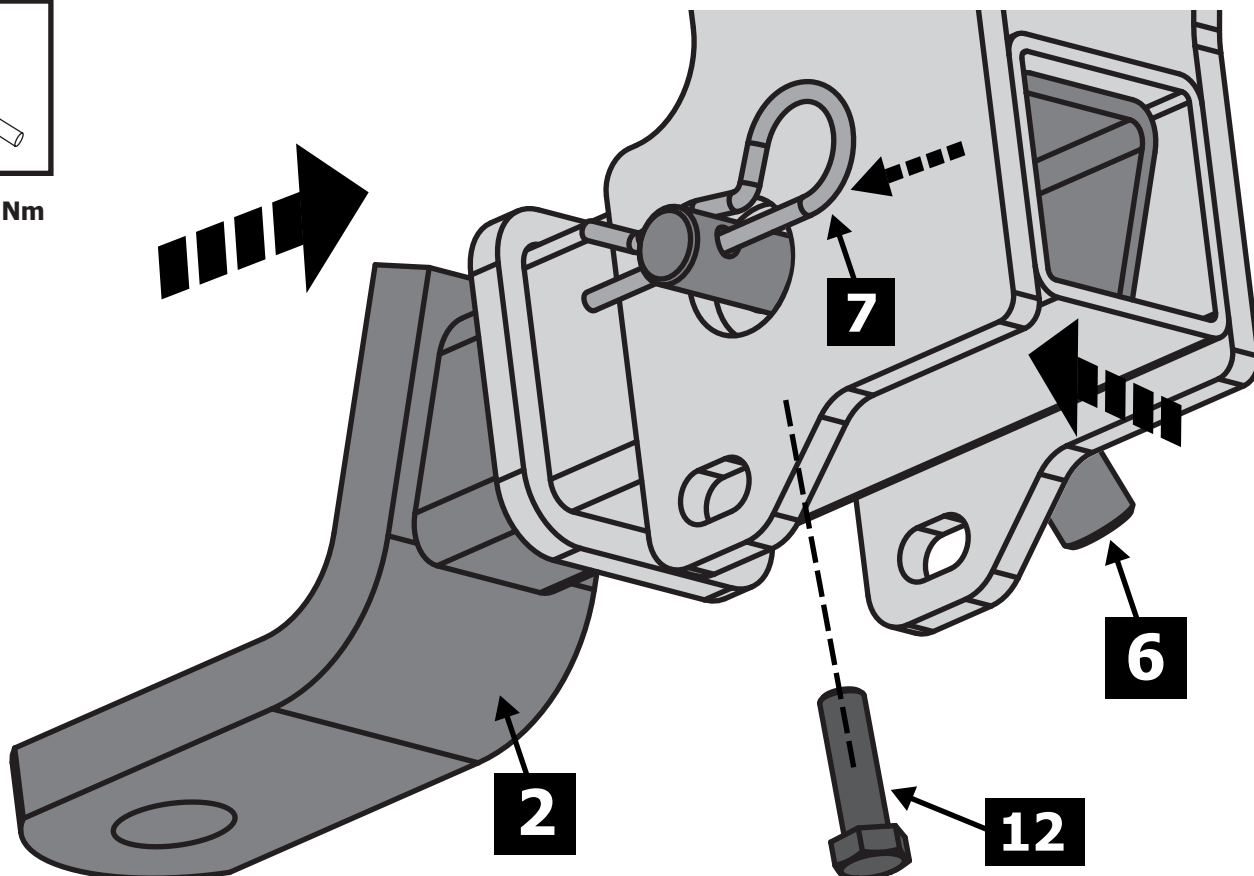

**18**

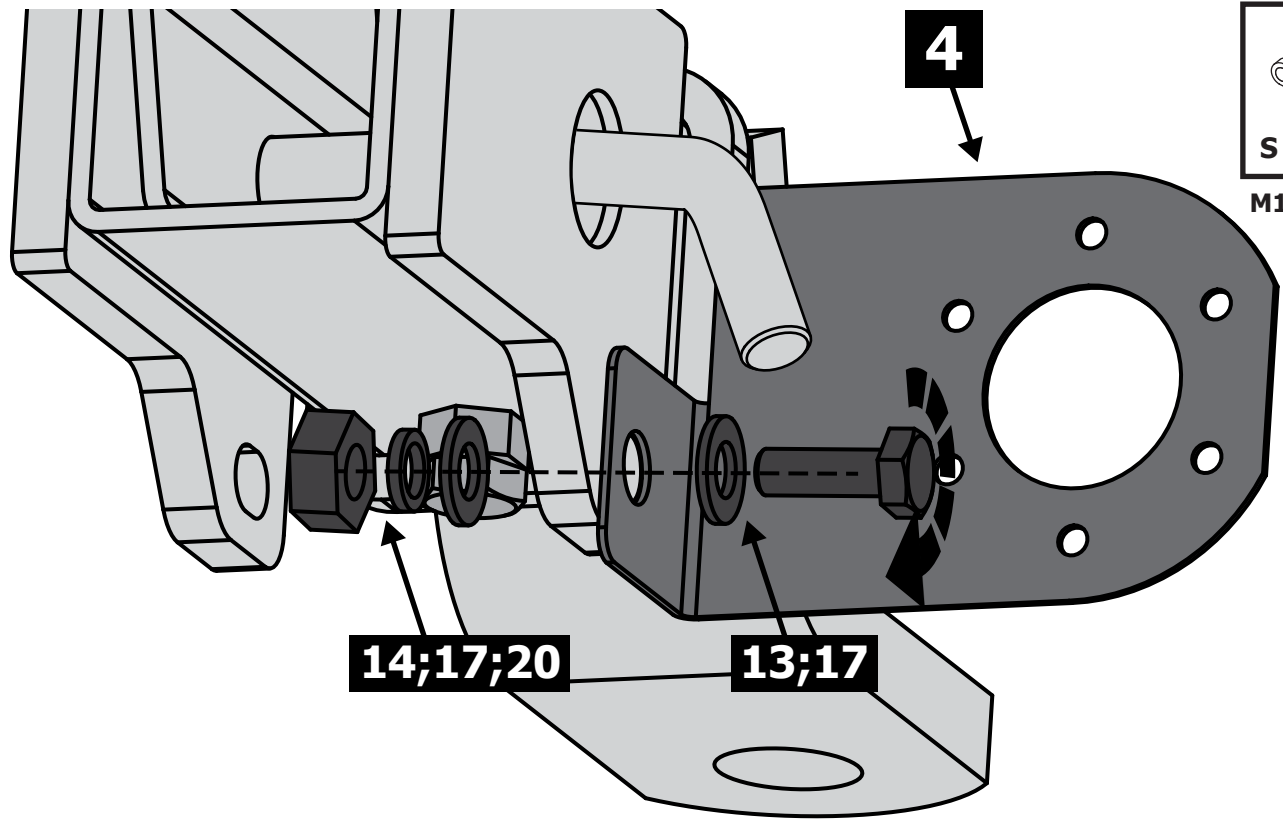

**19**

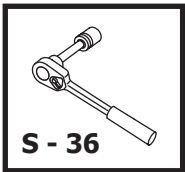

$M24 = 95 \text{ Nm}$

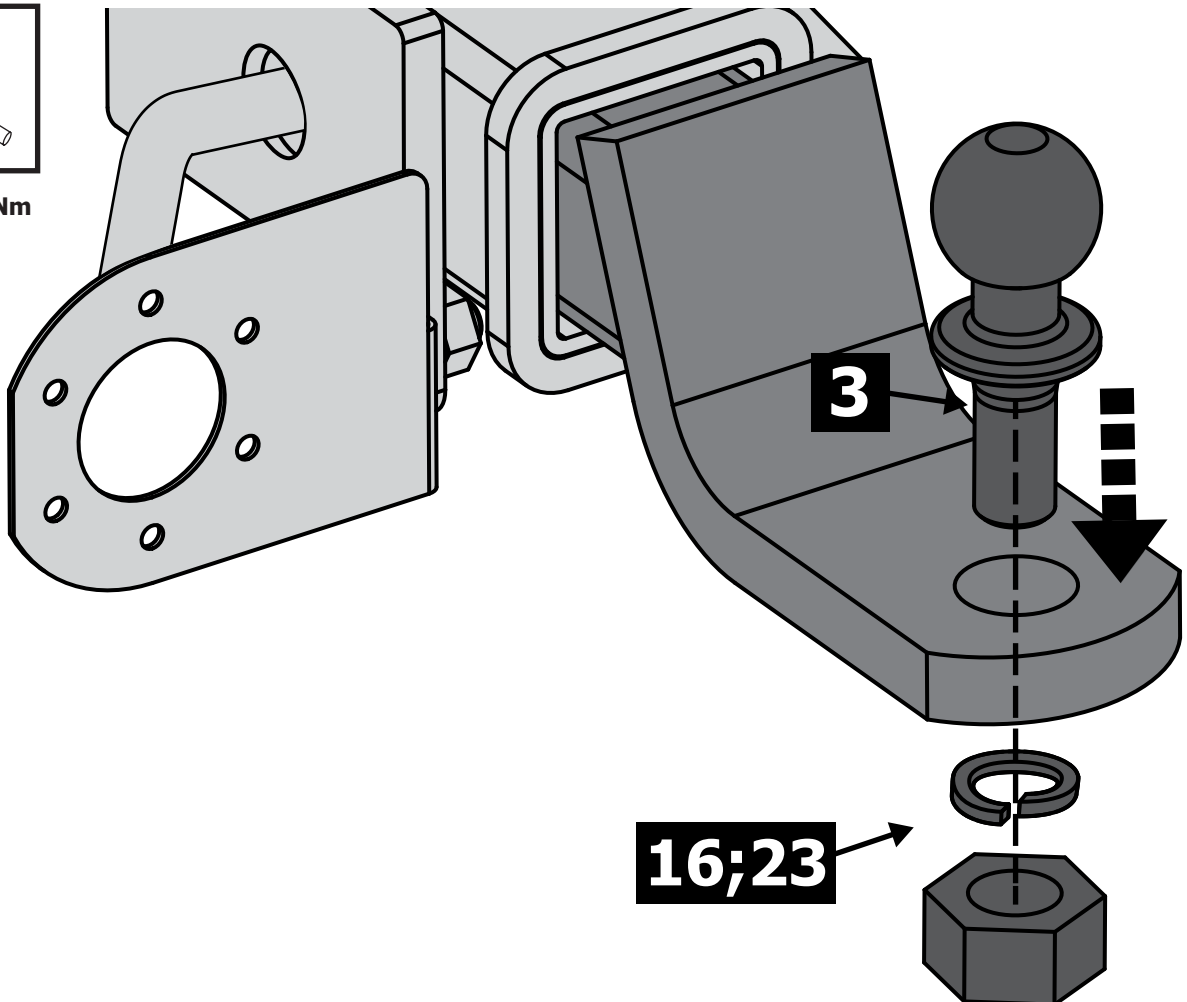

**20**

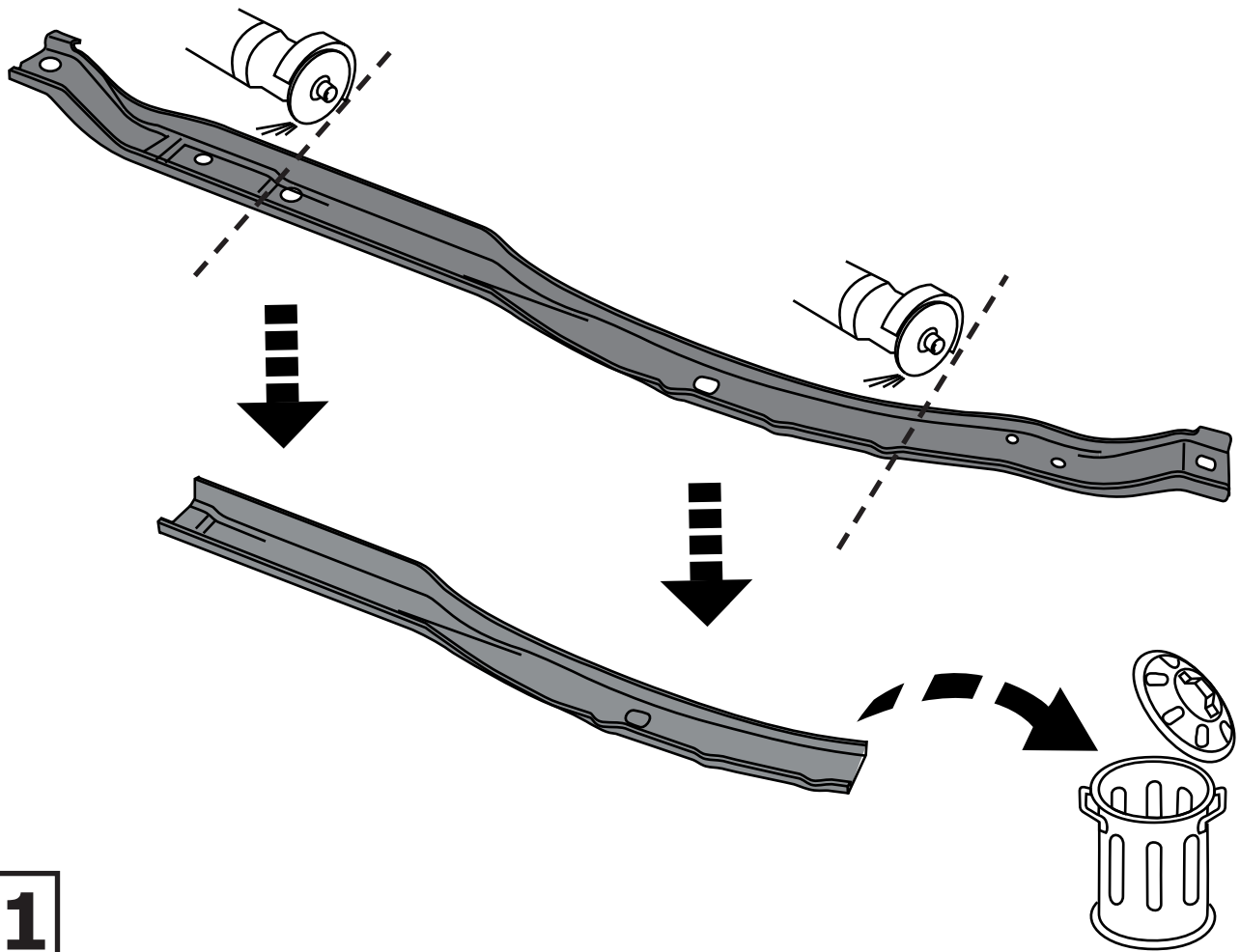

**21**

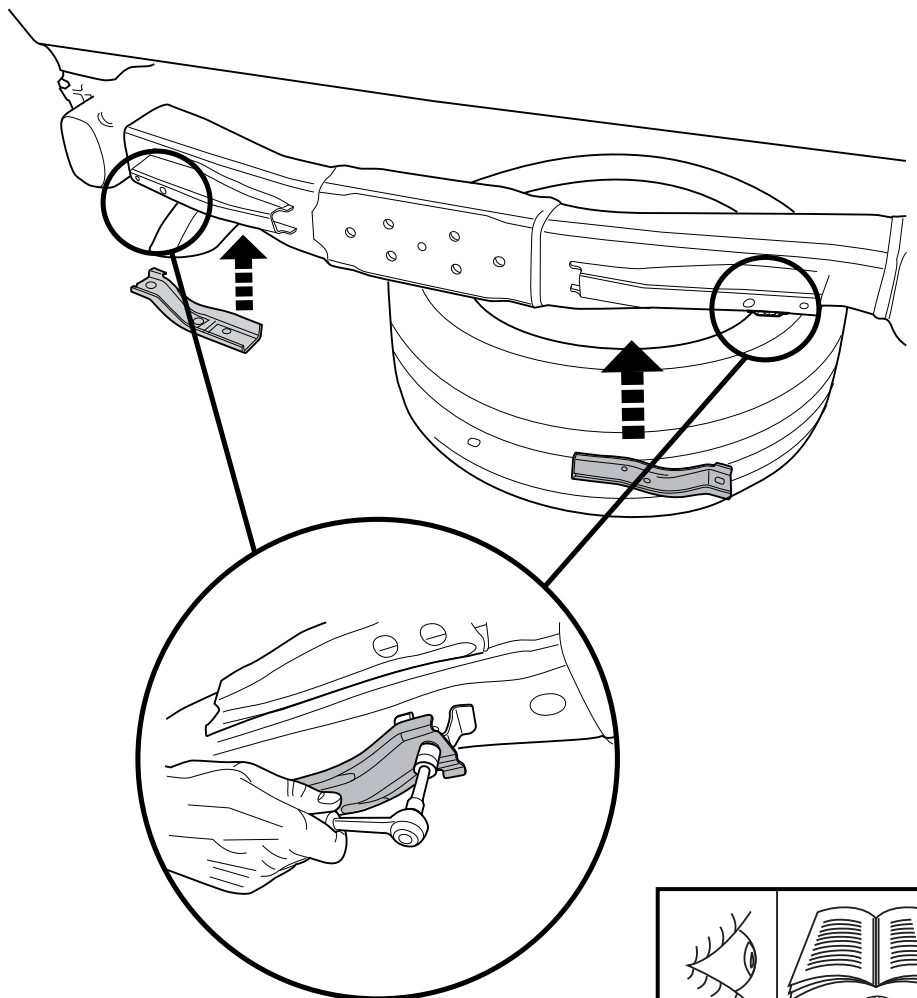
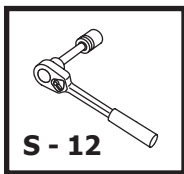
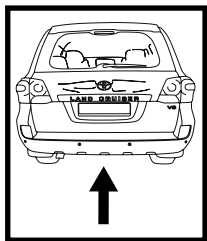

**22**

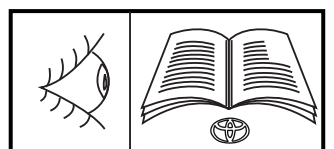

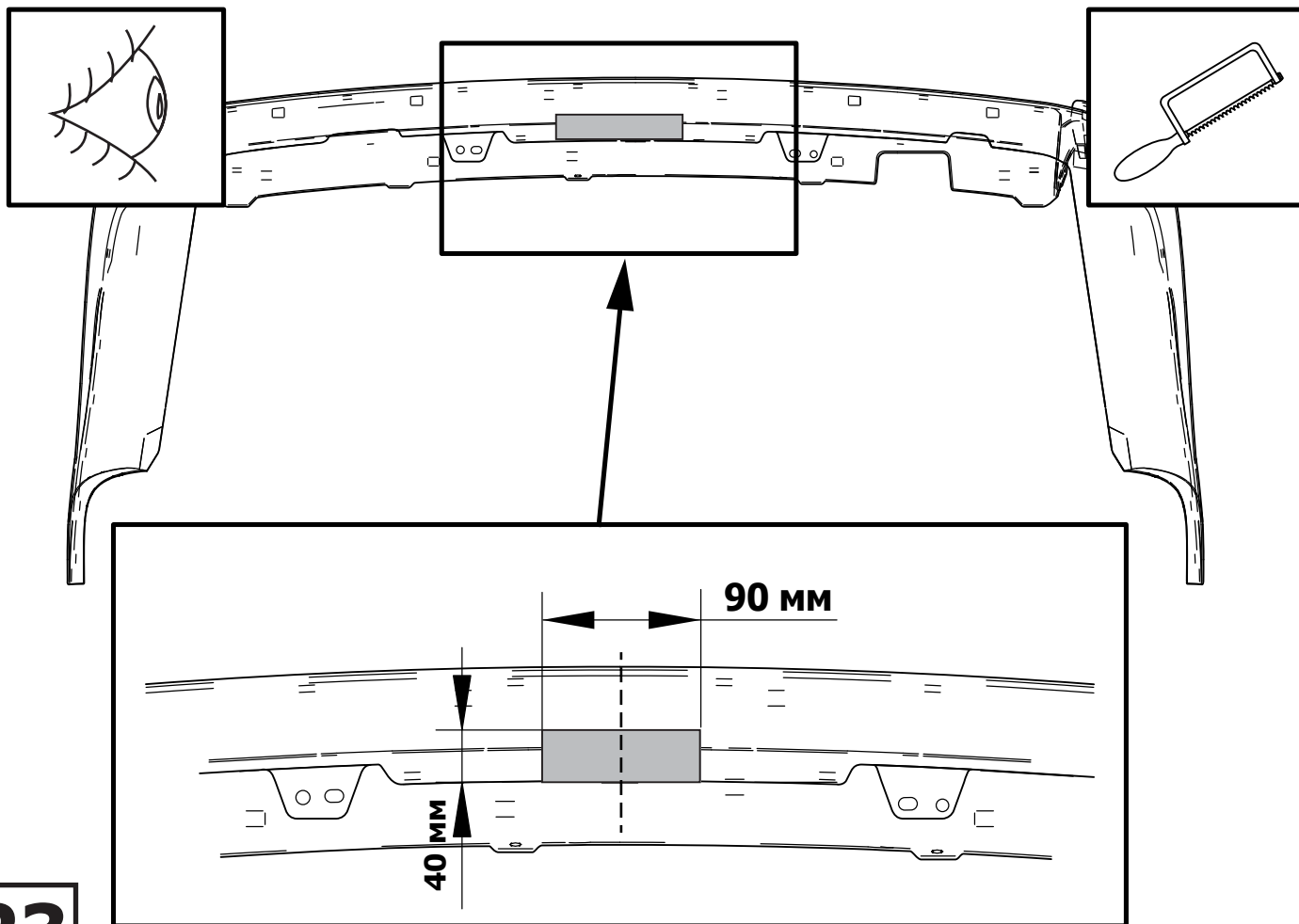

**23**

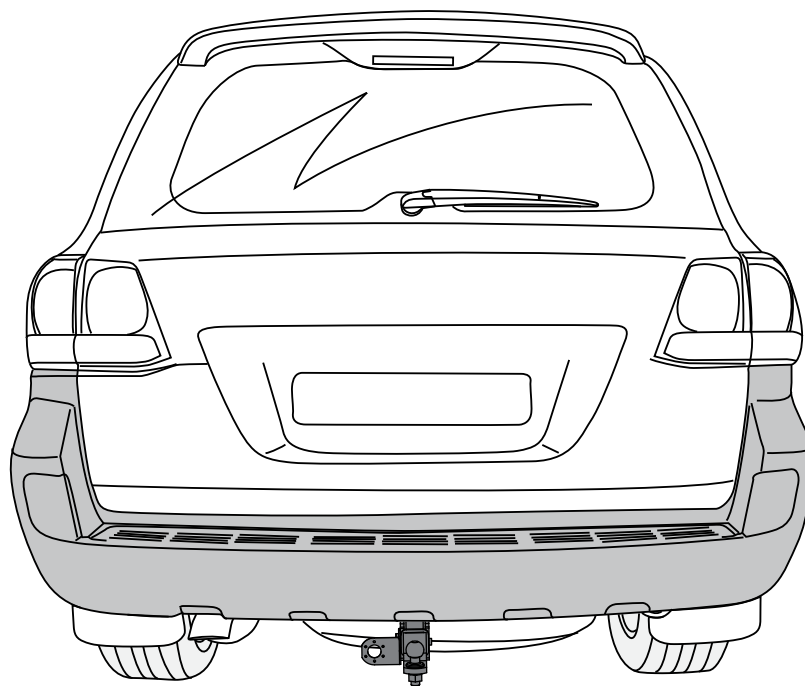
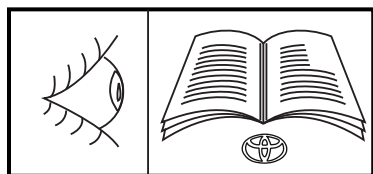

Установить бампер в последовательности  
обратной снятию (стр. 2 - 9)

**24**