

SC 71 105 031

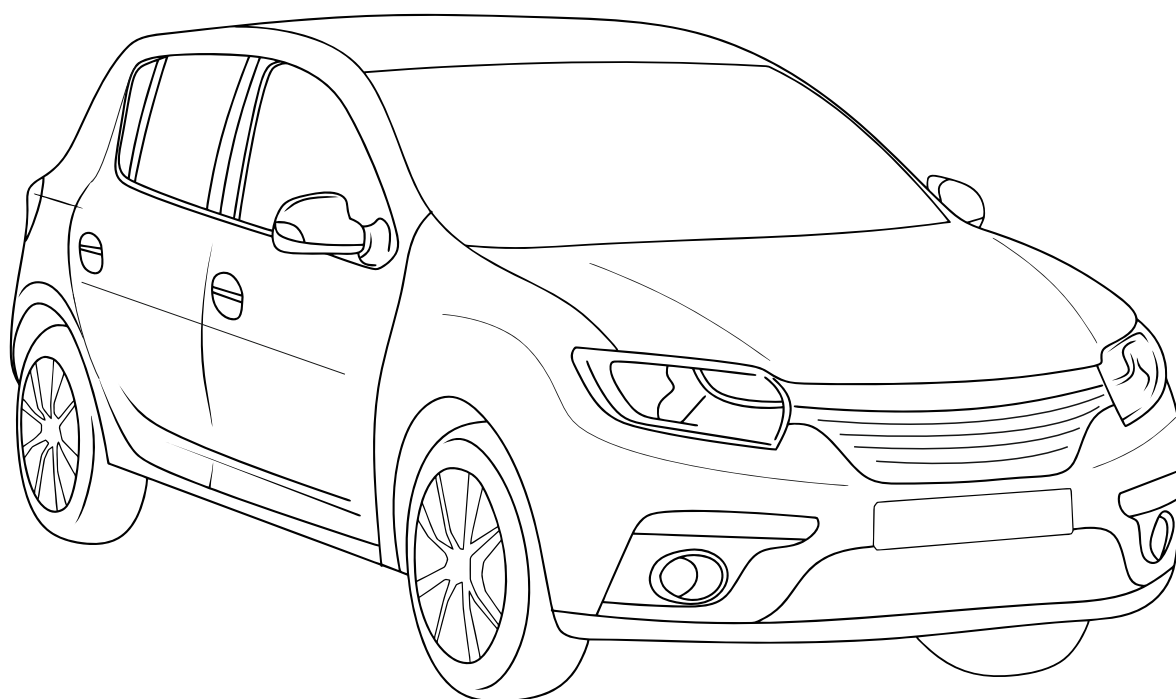

7-
(9200-76)



Renault Sandero 2014-

- 1.
- 2.
- 3.
- 4.

!

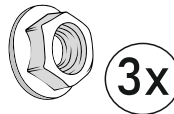
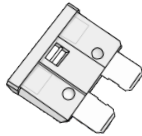
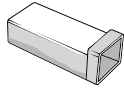
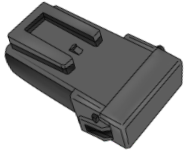
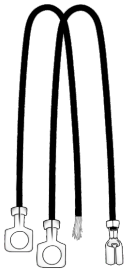
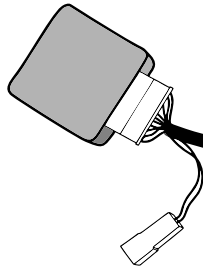
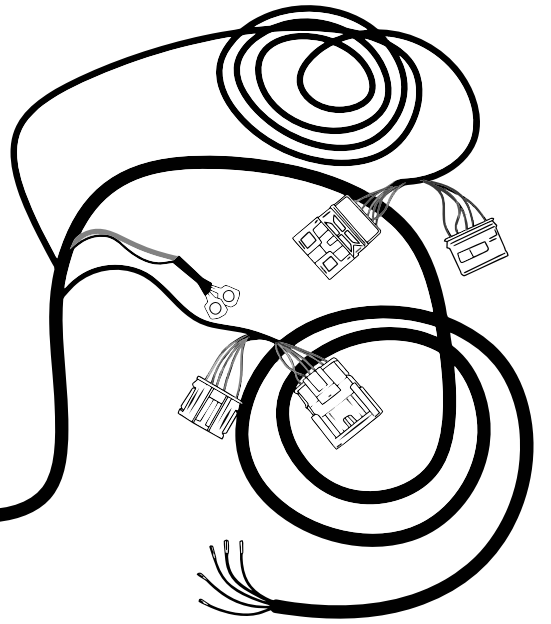
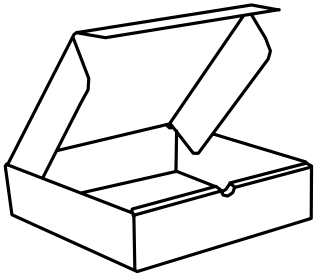

!

!

!

(_____)
CODE (_____).

(_____) !

, CODE

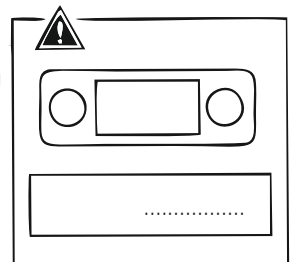
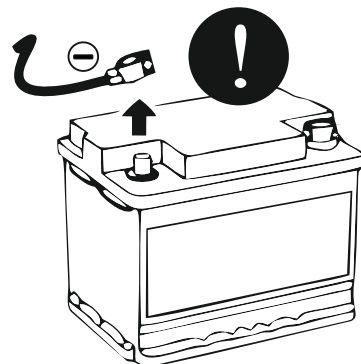

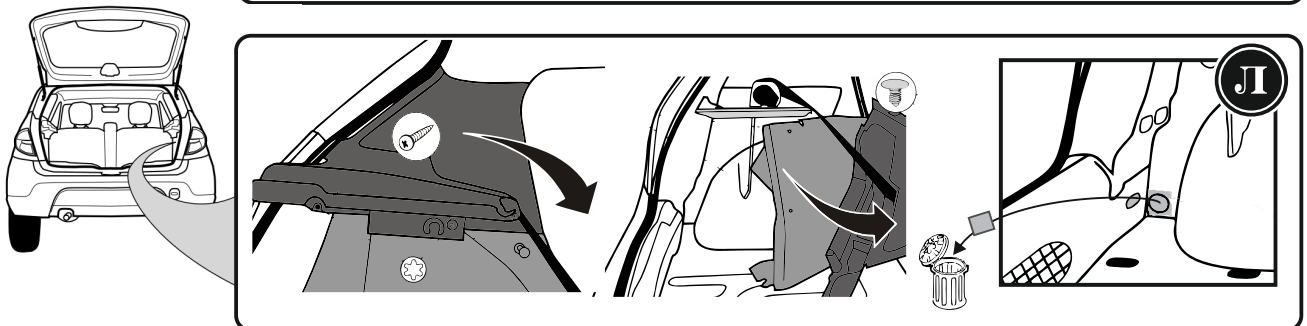
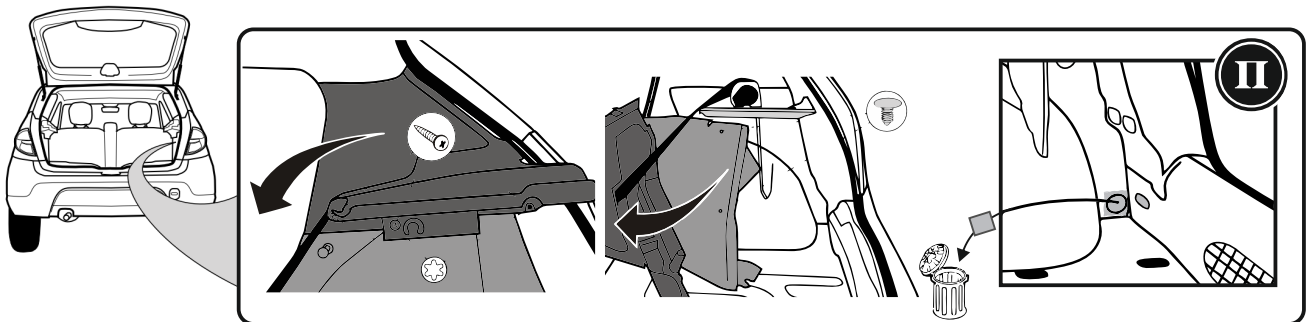
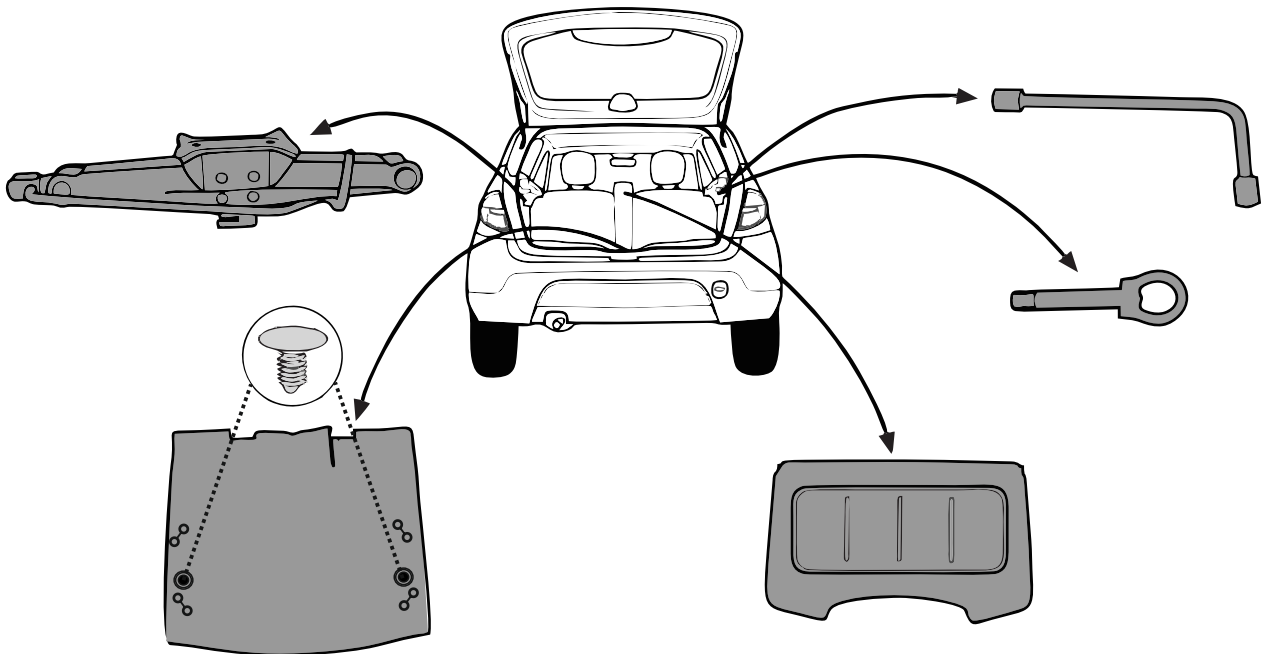
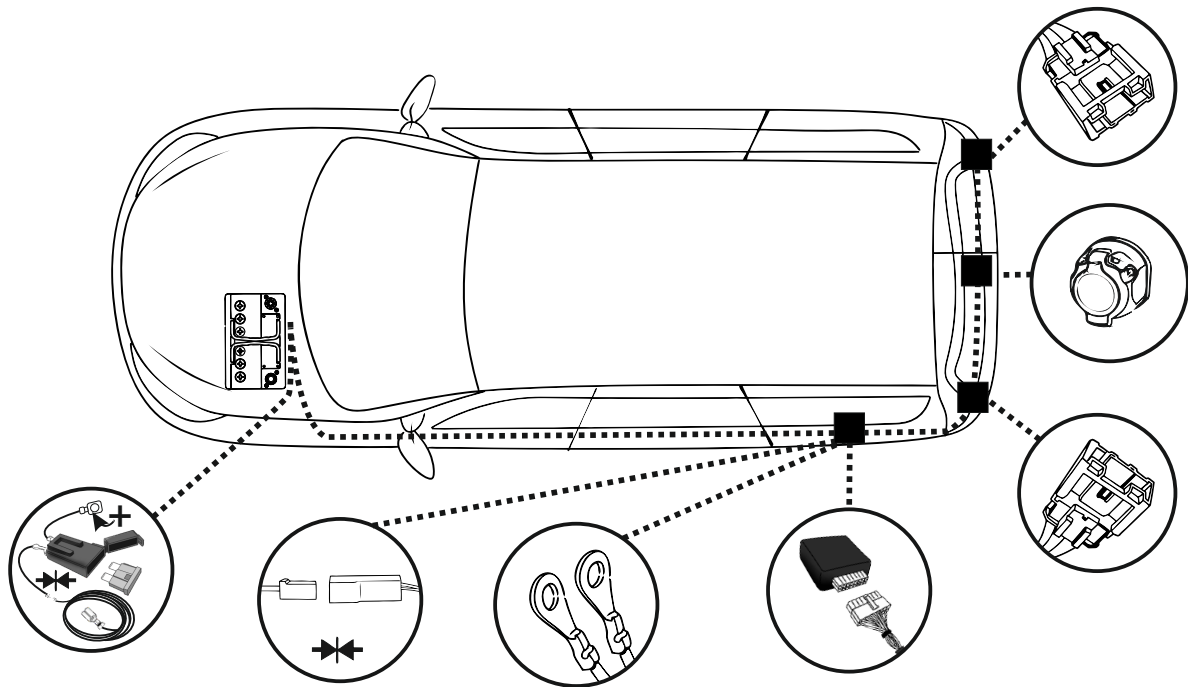

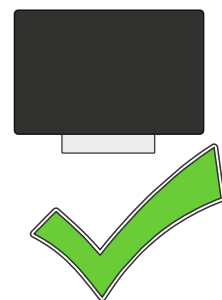
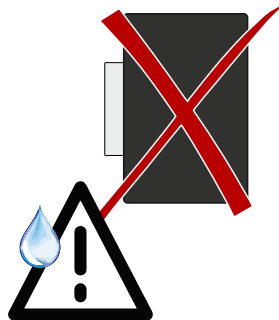
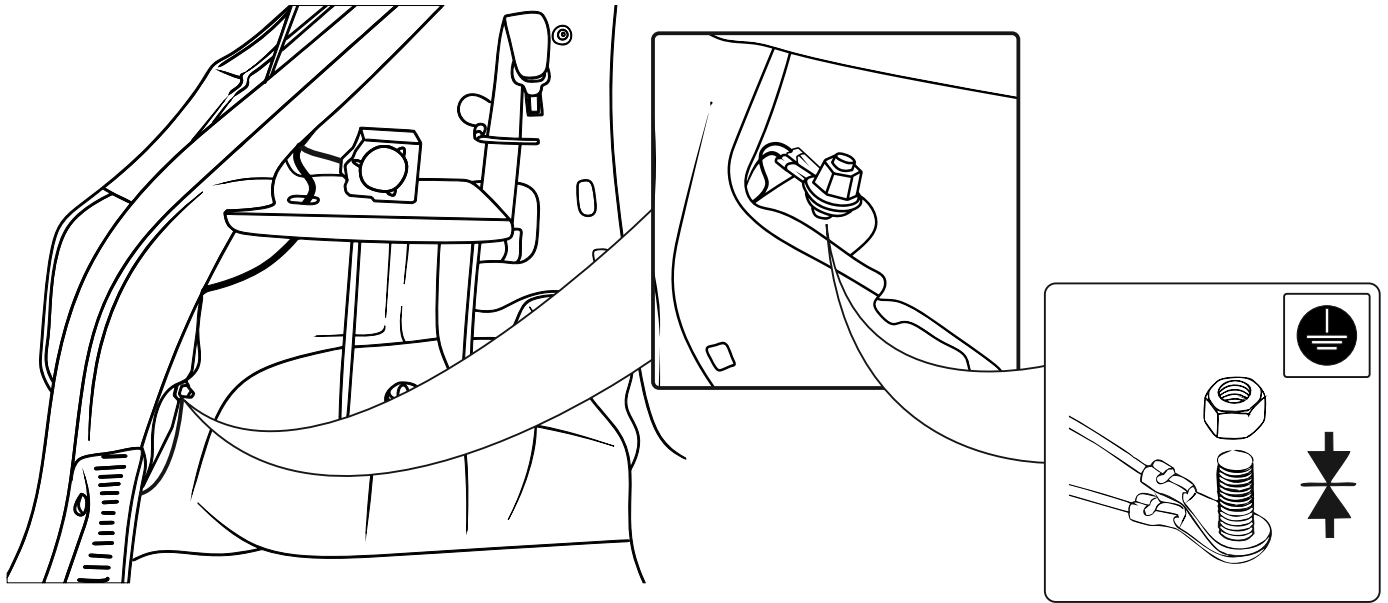
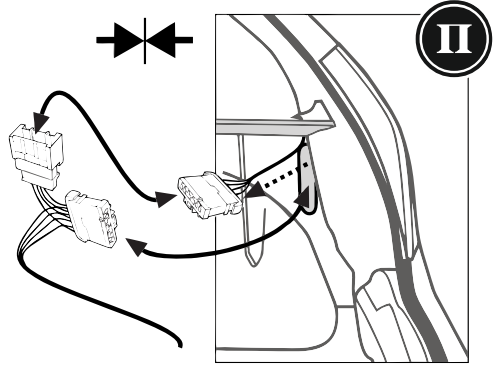
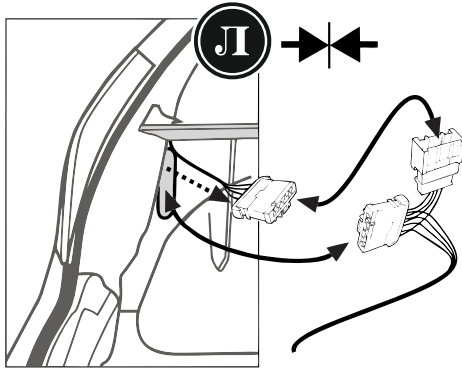
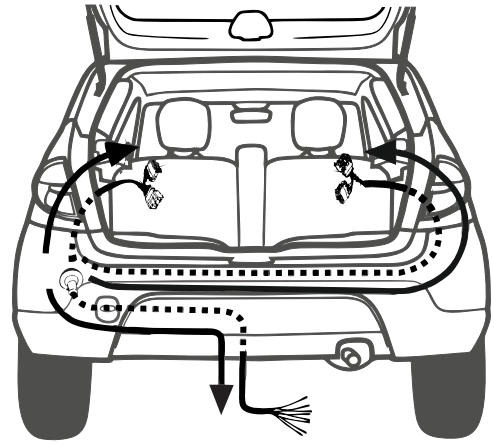
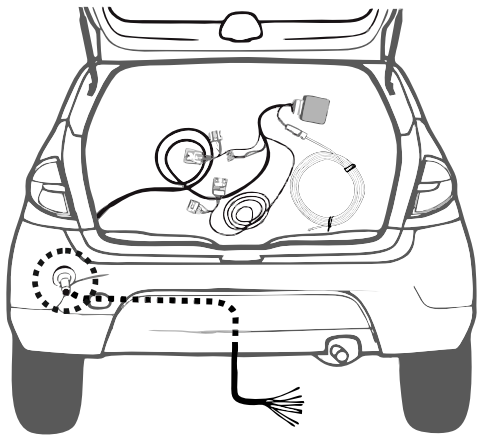

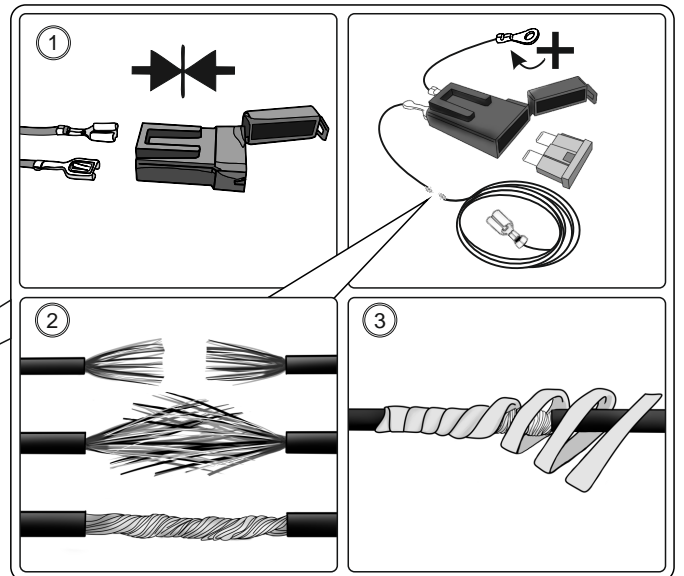
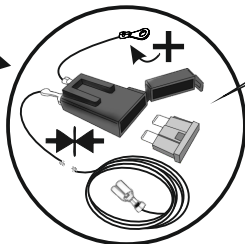
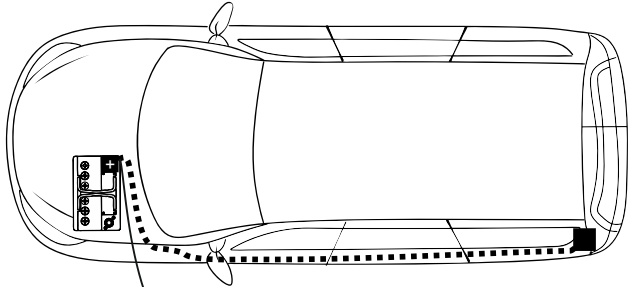
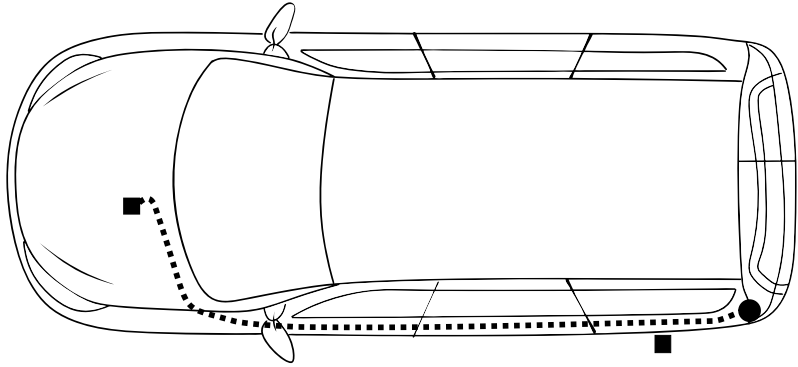
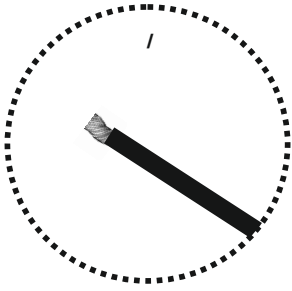
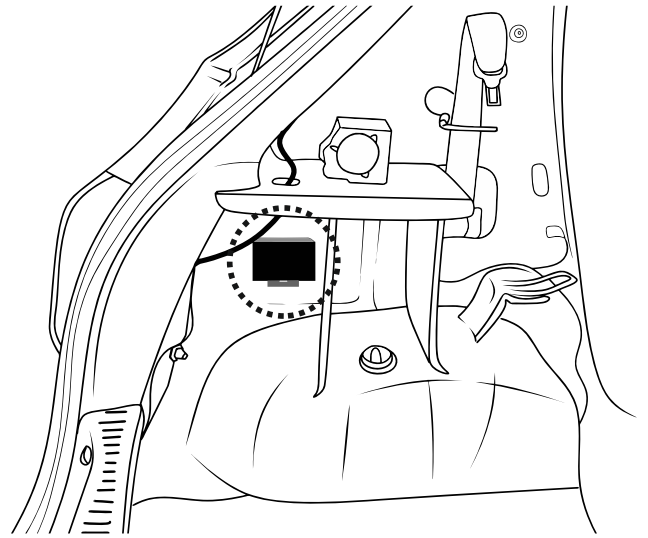
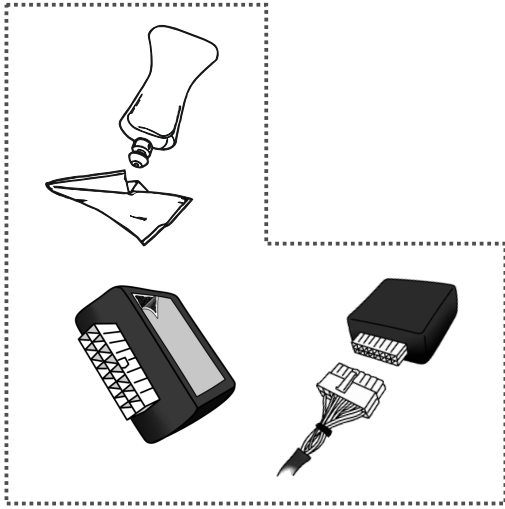

*

9200-76

1/L	2	3/31	4/R	5/58-R	6/54	7/58-L
21W	2x21W		21W	21W	2x21W	21W
				-		

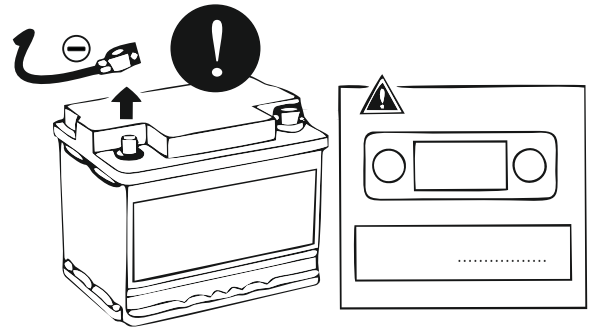
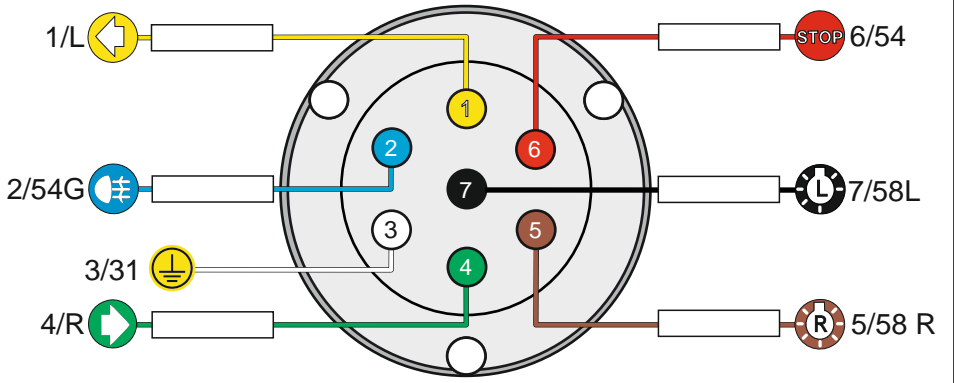
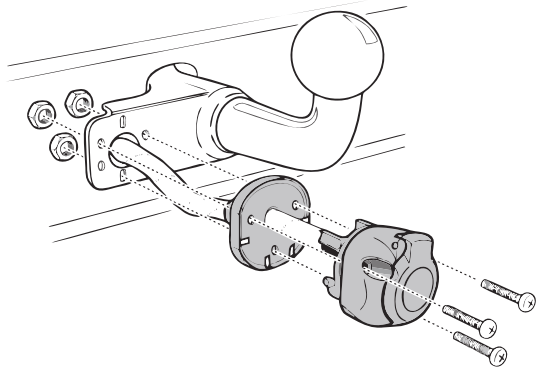

[Empty box]

