



## KIA SORENTO

2015 -

Cat. No. **K/045**

**E20**

E20 55R-01 4817

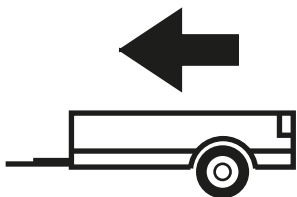

2500kg

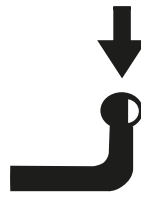

100kg

**D** = 12,60kN

**D (kN) =**



MAX kg

x

MAX kg

x 0,00981



MAX kg

+

MAX kg

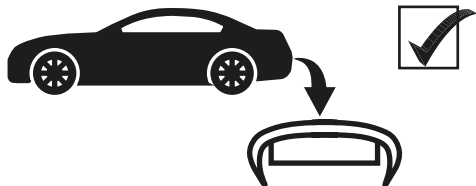

IMIOLA HAK-POL

96-111 KOWIESY, CHOJNATA 23A, POLAND

Tel. + 48 46 831 73 31, fax +48 831 74 29

e-mail: office@imiola.pl, www.imiola.pl

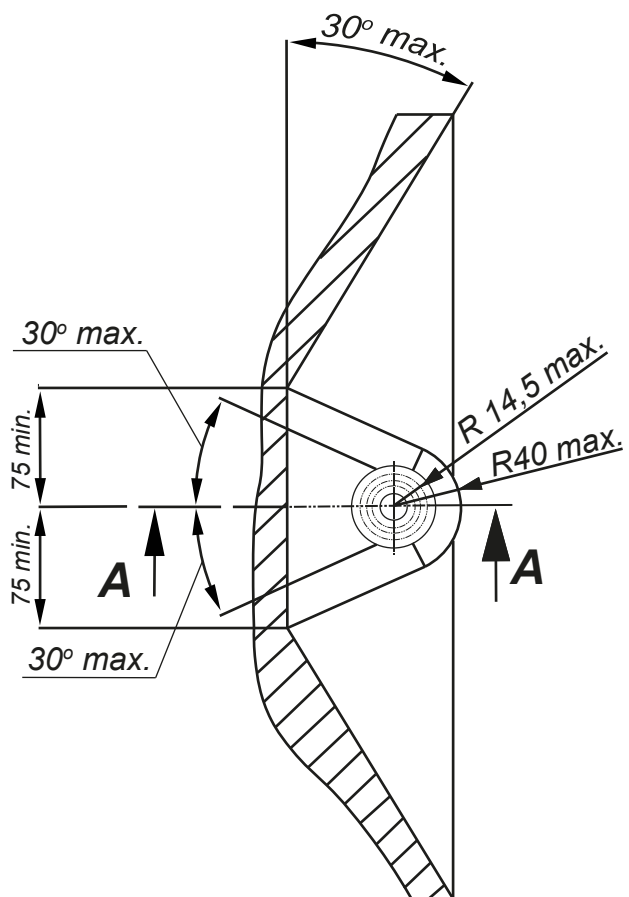

## PRZEKRÓJ A-A

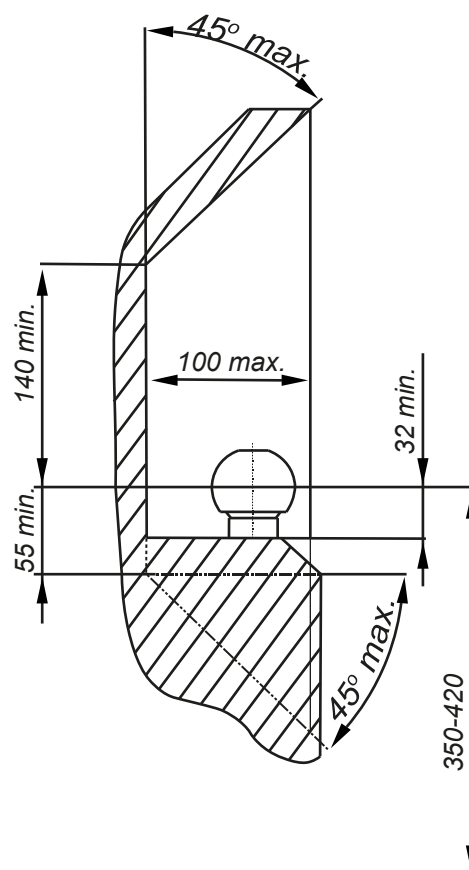

**PL** Należy zagwarantować przestrzeń swobodną według załącznika VII, rysunek 25a/b Regulaminu EKG ONZ 55.01 przy dopuszczalnym ciężarze całkowitym pojazdu.

**F** L'espace libre doit être garanti conformément à l'annexe VII, illustration de la réglementation 55.01 CE pour un poids total en charge autorisé du véhicule.

**GB** The clearance specified in appendix VII, diagram 25a/b of Regulation No. 55.01 UN EU must be guaranteed at laden weight of the vehicle.

**D** Der Freiraum nach Anhang VII, Abbildung 25a/b der Vorschriften 55.01 EG ist zu gew 25a/b abzuweihen bei zulässigem Gesamtgewicht des Fahrzeuges.

Moment skręcający dla śrub i nakrętek (8.8) Torque settings for nuts and bolts (8.8)	
M8	25Nm
M10	55Nm
M12	85Nm
M14	135Nm
M16	195Nm

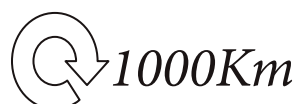

Nakrętka M12 ; Nut  
 Podkł. spręż. 12,2 ; Spring Washer  
 Podkł. okr. 13 ; Plain Washer

Śruba M12x120-8.8 ; Bolt

Nakrętka M12 ; Nut  
 Podkł. spręż. 12,2 ; Spring Washer  
 Podkł. okr. 13 ; Plain Washer

Nakrętka M12 ; Nut  
 Podkł. spręż. 12,2 ; Spring Washer  
 Podkł. okr. 13 ; Plain Washer

Śruba M12x120-8.8 ; Bolt











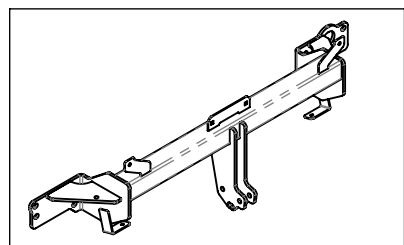
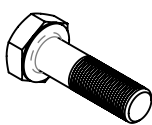

Śruba M12x50-8.8 ; Bolt  
 Podkł. okr. 13 ; Plain Washer

Nakrętka M12 ; Nut  
 Podkł. spręż. 12,2 ; Spring Washer  
 Podkł. okr. 13 ; Plain Washer

Śruba M12x50-8.8 ; Bolt  
 Podkł. okr. 13 ; Plain Washer

Śruba M12x50-8.8 ; Bolt  
 Podkł. okr. 13 ; Plain Washer

Śruba M12x70-8.8 ; Bolt

	A	x1		M12x120	4
	B	x1		M12	14
	C	x1		13	14
	D	x1		12,2	14
	E	x1			
	F	x1			
	G	x1			
	H	x1			
	I	x1			
	J	x1			

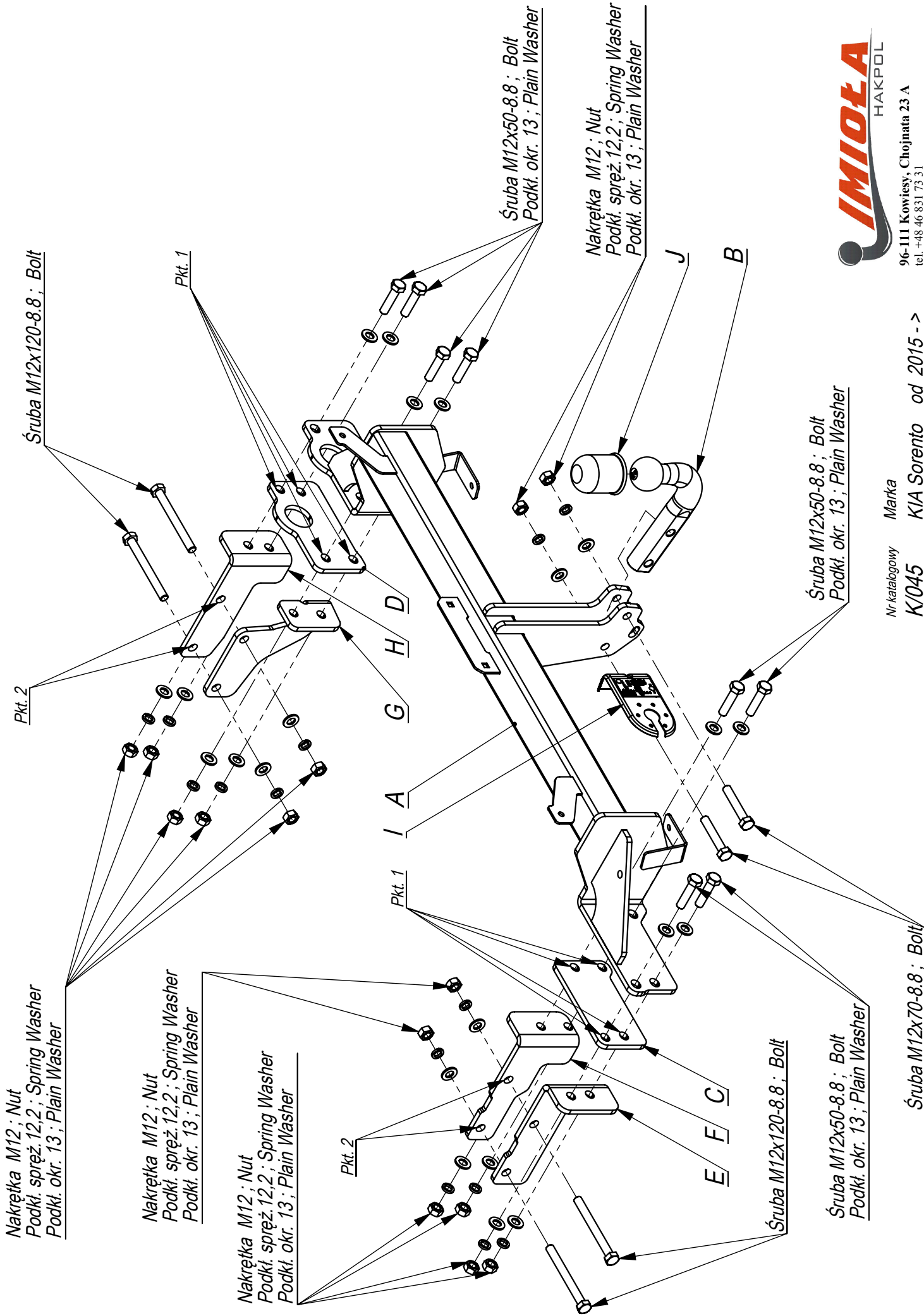

96-111 Kowiesy, Chojnata 23 A  
tel. +48 46 831 73 31

Nr katalogowy Marka  
K/045 KIA Sorento od 2015 ->

- Odkręcić lampy, zderzak i wzmocnienie (nie będzie wykorzystane)
- Elementy E i F oraz elementy G i H przykręcić do podłużnic śrubami M12x120 (pkt 2).
- Belkę haka A przykręcamy do tylnego pasa śrubami M12x50 8.8 (pkt1) stosując dystanse C i D.
- Wycinamy w dolnej części zderzaka fragment na szerokość mocowania kuli oraz gniazda elektrycznego.
- Montujemy zderzak, lampy i koło zapasowe
- Dokręcić wszystkie śruby z momentem według tabeli.
- Dokręcić kulę i blachę gniazda elektrycznego.
- Podłączyć instalację elektryczną.

- Unscrew the lamps, bumper and reinforcement (it will not be used any more).
- Screw the elements E, F and G, H to the frame side members with bolts M12x120 (point 2).
- Screw the main bar A to the rear belt with bolts M12x50 8.8 (point 1) using distance sleeves C and D.
- Cut out the fragment in the lower part of the bumper to fit the handles of the towball and electric plate.
- Assemble the bumper, lamps and spare wheel.
- Tighten all bolts according to the torque setting -see the table.
- Fix ball and electric plate.
- Connect electric wires.

- Dévissez lampes, le pare-chocs et dévisser le remplissage de pare-chocs. (elle ne sera plus utilisée).
- Les éléments E et F et les éléments G et H visser légèrement sur les éléments du châssis avec des vis M12x120 (point 2).
- La barre a crochet A est vissée a la ceinture arriere avec des boulons M12x50 8.8 (point 1) en utilisant les distances C et D.
- Nous avons coupé dans la partie inférieure de la partie de montage de pare-chocs de la largeur de la balle et la prise murale.
- Installer le pare-chocs et les lampes et le roue de secours.
- Serrer tous les boulons avec un couple de serrage selon tableau.
- Visser la boule et la tôle de la prise électrique.
- Brancher l'installation électrique.

- Die Rückleuchten, die Stoßstange und Verstärkung abschrauben (wird nicht mehr verwendet). E- und F-Elemente sollten mit M12x120-Schrauben (Punkt 2) an den Tragbalken verschraubt werden.
- E- und F-Elemente sollten mit M12x120-Schrauben (Punkt 2) an den Tragbalken verschraubt werden.
- Den AHK-Träger A mit Schrauben M12x50 8.8 (Punkt 1) anschrauben mit Distanzhülsen C und D.
- Schneiden Sie an der Unterseite des Stoßfängers das Fragment auf die Breite der Kugel und der Steckdose aus.
- Wir montieren Stoßstange, Lampen und Reserverad.
- Ziehen Sie alle Schrauben mit dem Drehmoment gemäß der Tabelle an.
- Die Kugel und den Steckdose-Blech anziehen.
- Die elektrische Installation anschließen.

- Desenrosque las lámparas, el parachoques y el refuerzo (ya no se utilizará).
- Apretar los elementos E y F y los elementos en el chasis con tornillos M12x120 (punto 2).
- Enganchamos el gancho A al cinturón trasero con los pernos M12x50 8.8 (punto 1) utilizando las distancias C y D.
- En la parte inferior del parachoques, corte el fragmento a la anchura de la bola y el enchufe eléctrico.
- Montamos el parachoques, las lámparas y la rueda de repuesto.
- Apretar todos los tornillos con el par según la tabla anterior.
- Apretar la bola y la placa de la toma eléctrica.
- Conectar la instalación eléctrica.

